



GRF2080

Ultra-LNA with Shutdown 0.1 to 1.5 GHz

FEATURES

- Excellent Noise Figure Performance
- High Isolation Shutdown State
- Flexible Bias Voltage
- Compact 2.0 x 2.0 mm DFN-8 Package
- Process: GaAs pHEMT

Reference: 5 V / 65 mA / 0.9 GHz

- Gain: 20.5 dB
- OIP3: 38.5 dBm
- OP1dB: 17.2 dBm
- Evaluation Board Noise Figure: 0.42 dB

APPLICATIONS

- Cellular Infrastructure
- Small Cells and Cellular Repeaters
- Distributed Antenna Systems
- TDD Systems

DESCRIPTION

The GRF2080 is a broadband, linear, ultra-low noise amplifier designed for small cell, wireless infrastructure and other high performance RF applications requiring ultra-low NF, high gain and linearity.

The device features an integrated shutdown function which places the device into a high-isolation shutdown state.

This device is a member of a family of pin-compatible, ultra-low noise devices which cover a wide range of frequency bands with industry leading NF and gain:

GRF2080: 0.1 to 1.5 GHz **GRF2081:** 0.7 to 2.7 GHz

GRF2082: 1.5 to 3.8 GHz **GRF2083:** 2.0 to 6.0 GHz

Please consult with the GRF applications engineering team for custom tuning/evaluation board data and device s-parameters.

BLOCK DIAGRAM

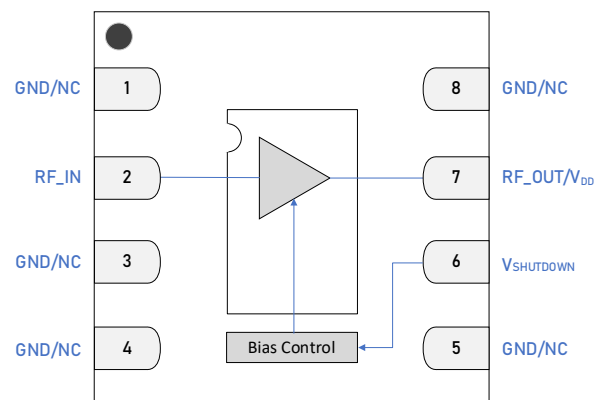

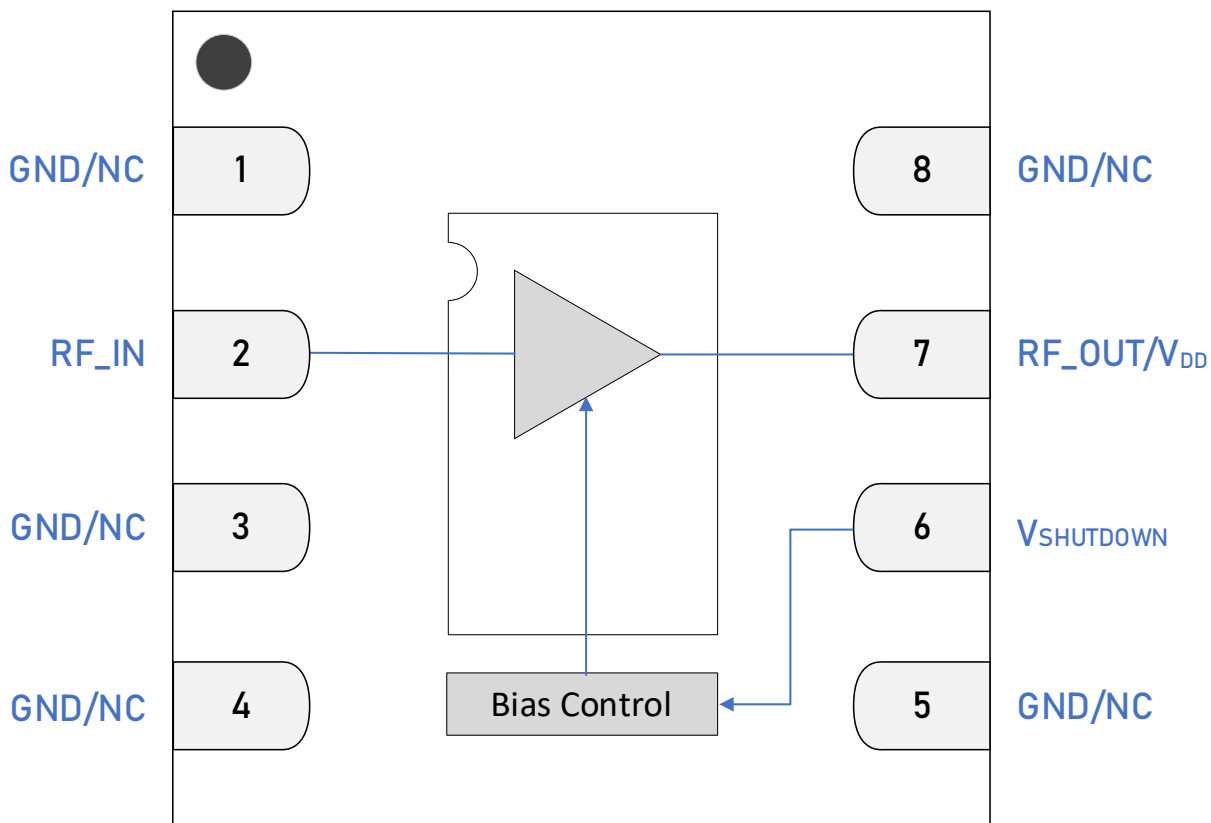

2.0 x 2.0 mm DFN-8 Pin Out (Top View)

Pin Assignments

Pin	Name	Description	Note
1, 3, 4, 5, 8	GND/NC	Ground or No Connect	No internal connection to die. We recommend connecting these pins to GND.
2	RF_IN	RF Input	External match must provide DC block.
6	V _{SHUTDOWN}	Selects Shutdown Mode	See Control Logic Truth Table.
7	RF_Out/V _{DD}	RF Output	Provide device V _{DD} via external bias inductor.
PKG BASE	GND	Ground	Provides DC and RF ground for LNA, as well as thermal heat sink. Recommend multiple 8 mil vias beneath the package for optimal RF and thermal performance. Refer to evaluation board top layer graphic on schematic page.

Control Logic Truth Table

Mode	Description	V _{DD}	V _{SHUTDOWN}
High Gain	LNA Gain	High	Low
Shutdown	LNA Insertion Loss	High	High
Logic Level "0"	Logic Low	0 V	0 V to 0.2 V
Logic Level "1"	Logic High	≥ 2.7 V	1.5 V to V _{DD}

Absolute Ratings

Parameter	Symbol	Min.	Max.	Unit
Supply Voltage	V_{DD}	0	6	V
RF Input Power (CW, Load VSWR < 2:1, $V_{DD} = 5$ V)	$P_{IN\ MAX}$		23	dBm
Operating Temperature (Package Heat Sink)	$T_{PKG\ HEAT\ SINK}$	-40	105	°C
Maximum Channel Temperature (MTTF > 10 ⁶ Hours)	T_{MAX}		170	°C
Maximum Dissipated Power	$P_{DISS\ MAX}$		500	mW

Electrostatic Discharge

Charged Device Model	CDM	1500		V
Human Body Model	HBM	500		V

Storage

Storage Temperature	T_{STG}	-65	150	°C
Moisture Sensitivity Level	MSL		1	--



Caution! ESD Sensitive Device.

Exceeding Absolute Maximum Rating conditions may cause permanent damage.

Note: For additional information, please refer to *Manufacturing Note MN-001 — Package and Manufacturing Information*.



All Guerrilla RF products are provided in RoHS compliant lead (Pb)-free packaging requiring no exemptions. Additional information for this topic can be found at this link - [Environmental and Restricted Substance Statement Library](#)

Recommended Operating Conditions

Parameter	Symbol	Specification			Unit	Condition
		Min.	Typ.	Max.		
Supply Voltage	V _{DD}	0	5	6	V	
Operating Temperature (Package Heat Sink)	T _{PKG HEAT SINK}	-40		105	°C	
RF Frequency Range	F _{RF}	0.1	0.9	1.5	GHz	Typical Application Schematic with external matching components (note 1 & 2).

Note 1: Operation outside this range is possible, but with degraded performance of some parameters.

Note 2: Contact the Guerrilla RF Applications team for guidance on optimizing the tuning of the device for alternative bands.

Nominal Operating Parameters – General

The following conditions apply unless noted otherwise: Typical Application Schematic using the 0.7 to 1 GHz tuning set, $V_{DD} = 5\text{ V}$, $V_{SHUTDOWN} = < 0.2\text{ V}$, $I_{DD} = 65\text{ mA}$, $F_{TEST} = 0.9\text{ GHz}$, $T_{PKG\ HEAT\ SINK} = 25\text{ }^{\circ}\text{C}$. Evaluation board losses are included within the specifications.

Parameter	Symbol	Specification			Unit	Condition
		Min.	Typ.	Max.		
Supply Current	I_{DD}	45	65	90	mA	$V_{DD} = 5\text{ V}$, $V_{SHUTDOWN} = 0\text{ V}$.
Switching Rise Time	T_{RISE}		100		ns	
Switching Fall Time	T_{FALL}		100		ns	

Thermal Data

Thermal Resistance: (Infrared Scan)	Θ_{JC}		60		$^{\circ}\text{C}/\text{W}$	On standard evaluation board (note 3).
-------------------------------------	---------------	--	----	--	-----------------------------	---

Note 3: MTTF > 10^6 hours for $T_{CHANNEL} \leq 170\text{ }^{\circ}\text{C}$.

Nominal Operating Parameters – RF

The following conditions apply unless noted otherwise: Typical Application Schematic using the 0.7 to 1 GHz tuning set, $V_{DD} = 5\text{ V}$, $V_{SHUTDOWN} = < 0.2\text{ V}$, $I_{DD} = 65\text{ mA}$, $F_{TEST} = 0.9\text{ GHz}$, $T_{PKG\ HEAT\ SINK} = 25\text{ }^{\circ}\text{C}$. Evaluation board losses are included within the specifications.

Parameter	Symbol	Specification			Unit	Condition
		Min.	Typ.	Max.		
Gain	S21	19.5	20.5		dB	
Evaluation Board Noise Figure	NF		0.42	0.62	dB	
Output 3 rd Order Intercept	OIP3		38.5		dBm	+4 dBm P_{OUT} per tone at 2 MHz spacing (899 and 901 MHz).
Output 1 dB Compression Point	OP1dB	15.7	17.2		dBm	

Shutdown Mode

Gain (RF_IN = -10 dBm @ 0.9 GHz).	S21		-36		dB	$V_{DD} = 5\text{ V}$, $V_{SHUTDOWN} = > 1.5\text{ V}$.
Gain (RF_IN = 10 dBm @ 0.9 GHz).	S21		-22		dB	$V_{DD} = 5\text{ V}$, $V_{SHUTDOWN} = > 1.5\text{ V}$.
Shutdown Current (pin 6)	$I_{SHUTDOWN}$		40		μA	$V_{DD} = 5\text{ V}$, $V_{SHUTDOWN} = 1.8\text{ V}$.
Leakage Current (pin 7)	$I_{LEAKAGE}$		3.5	6	mA	$V_{DD} = 5\text{ V}$, $V_{SHUTDOWN} = 1.8\text{ V}$.

Typical Operating Curve Conditions

The following conditions apply unless noted otherwise: Typical Application Schematic using the 0.7 to 1 GHz tuning set, $V_{DD} = 5\text{ V}$, $V_{SHUTDOWN} = < 0.2\text{ V}$, $I_{DD} = 65\text{ mA}$, $F_{TEST} = 0.9\text{ GHz}$, $T_{PKG\ HEAT\ SINK} = 25\text{ }^{\circ}\text{C}$. Evaluation board losses are included within the plots.

GRF2080 Typical Operating Curves: 0.7 to 1 GHz Tune

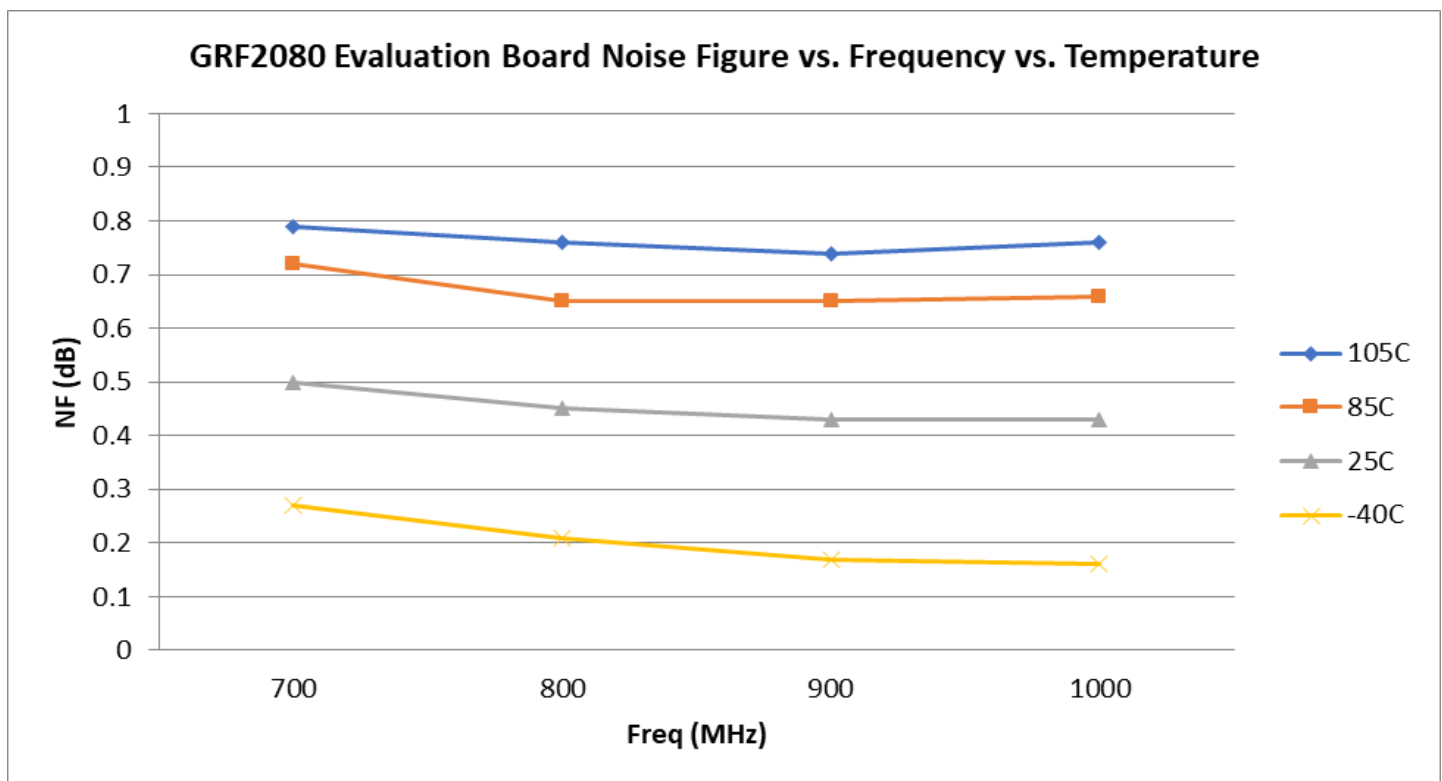
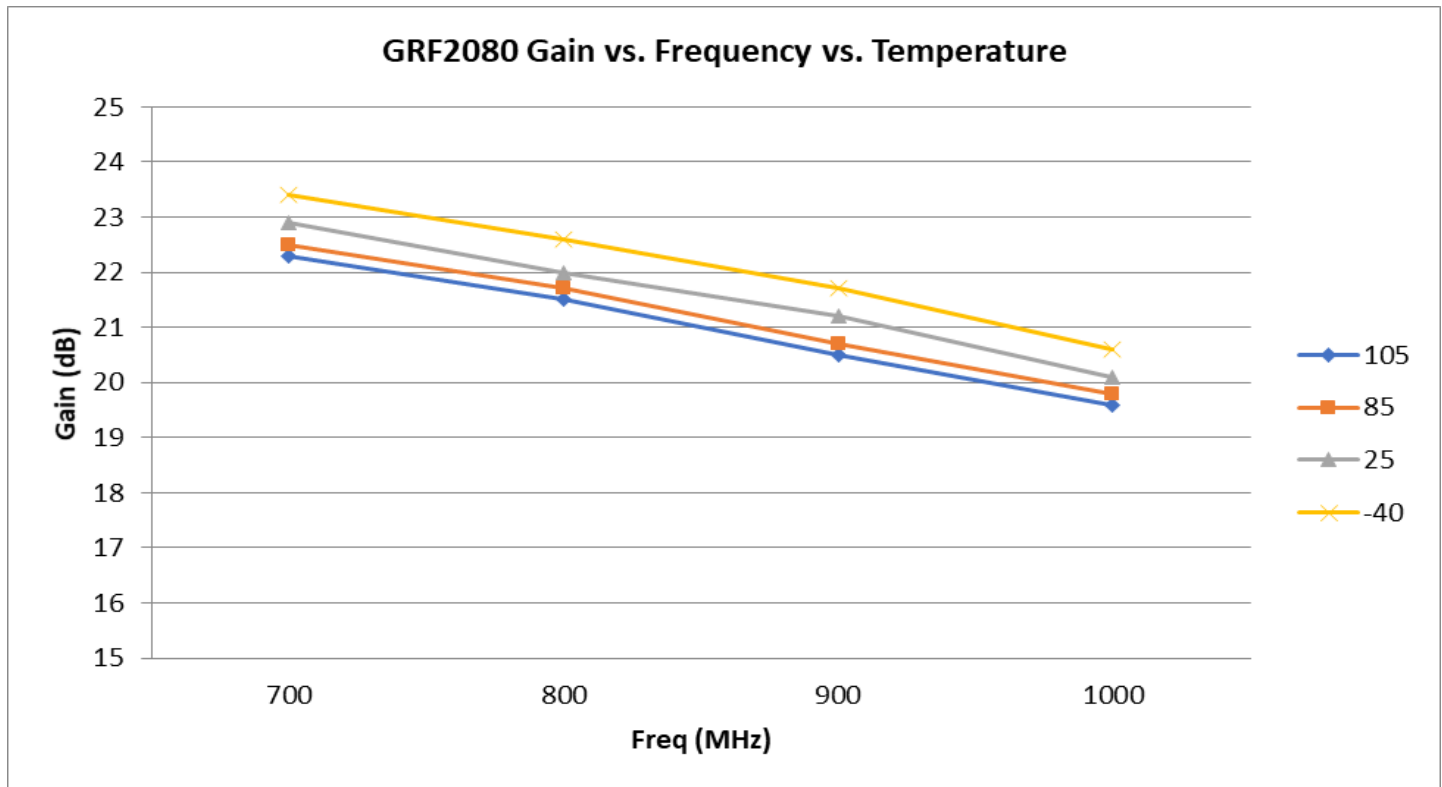

GRF2080 Typical Operating Curves: 0.7 to 1 GHz Tune

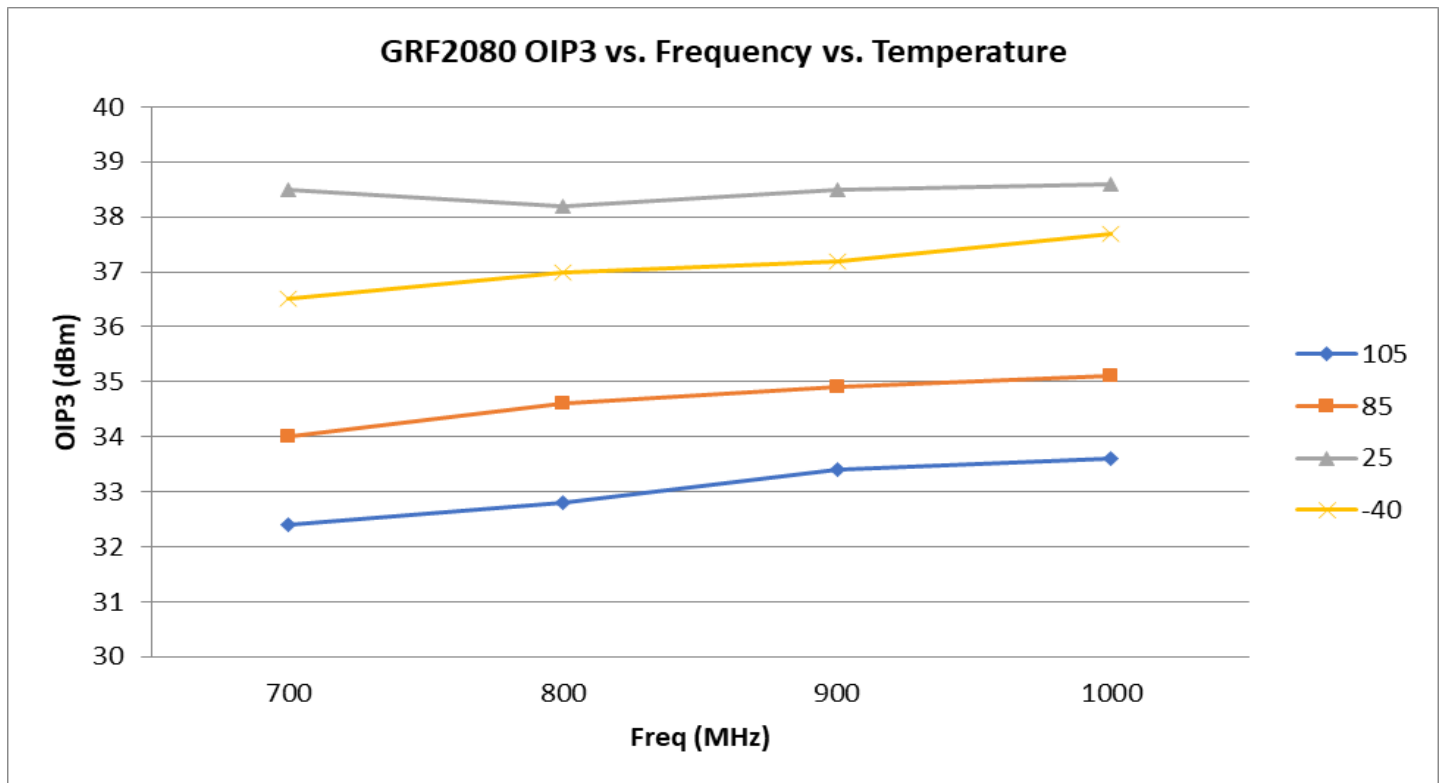
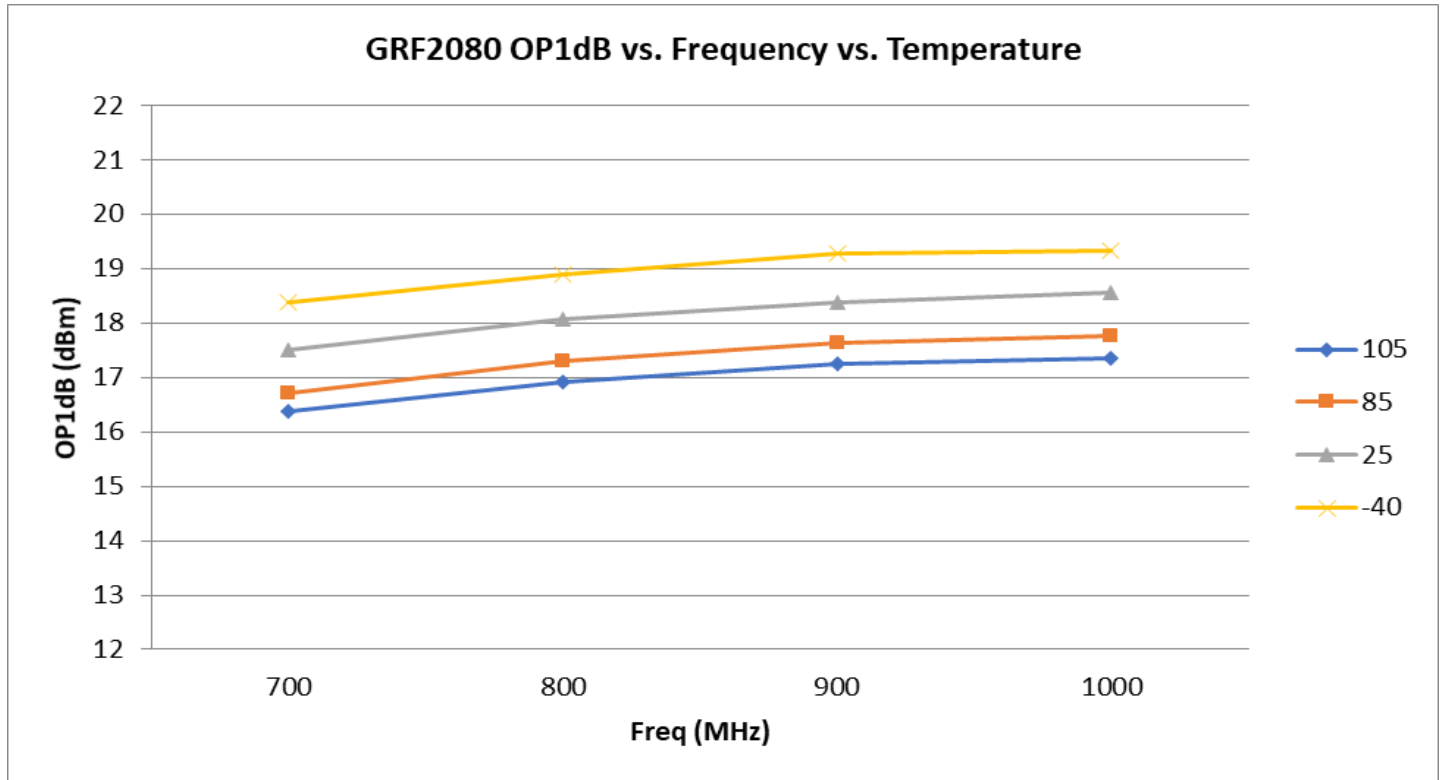

GRF2080 Typical Operating Curves: S-Parameters (0.7 to 1 GHz Tune)

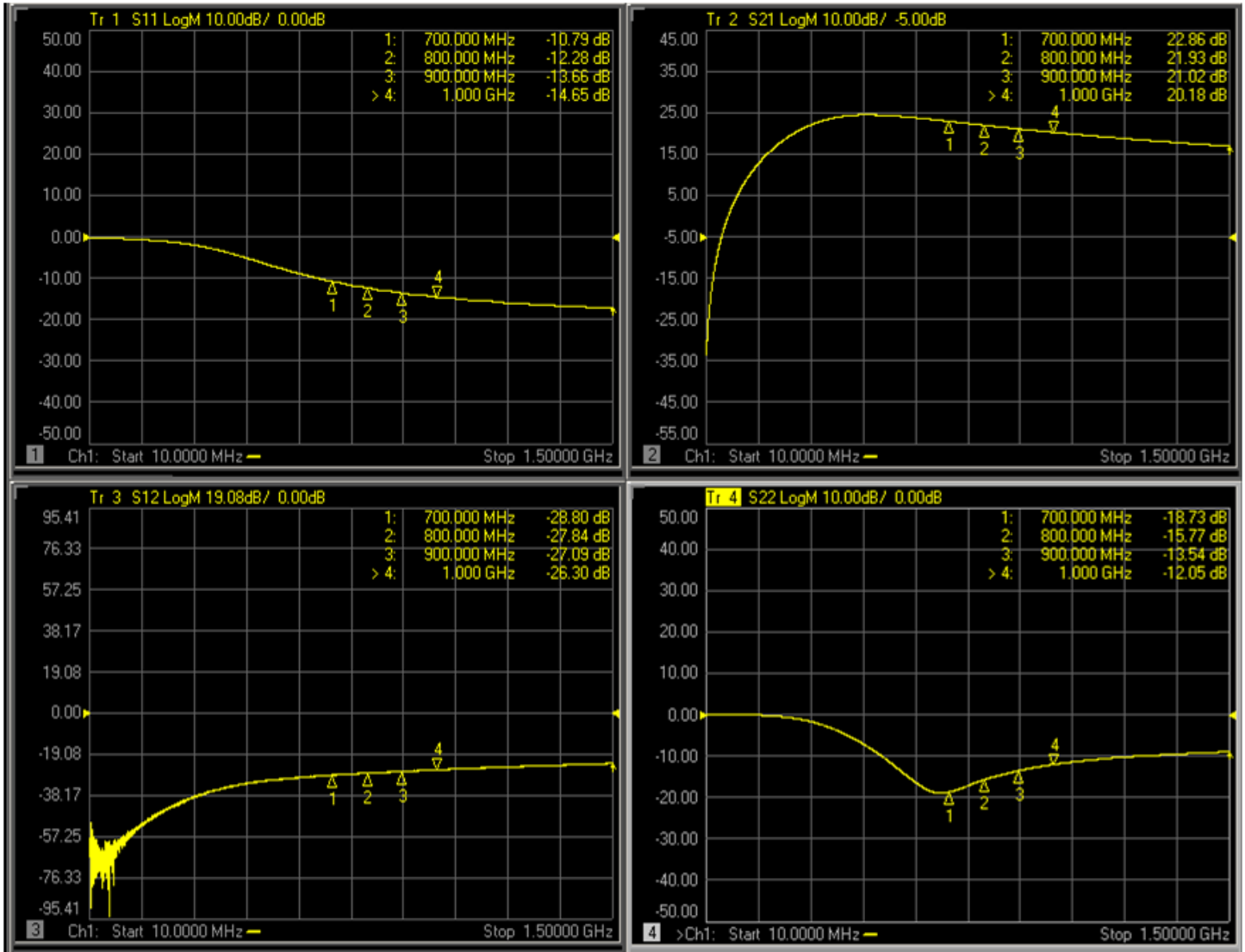

GRF2080 Typical Operating Curves: Stability Mu Factor (0.7 to 1 GHz Tune)

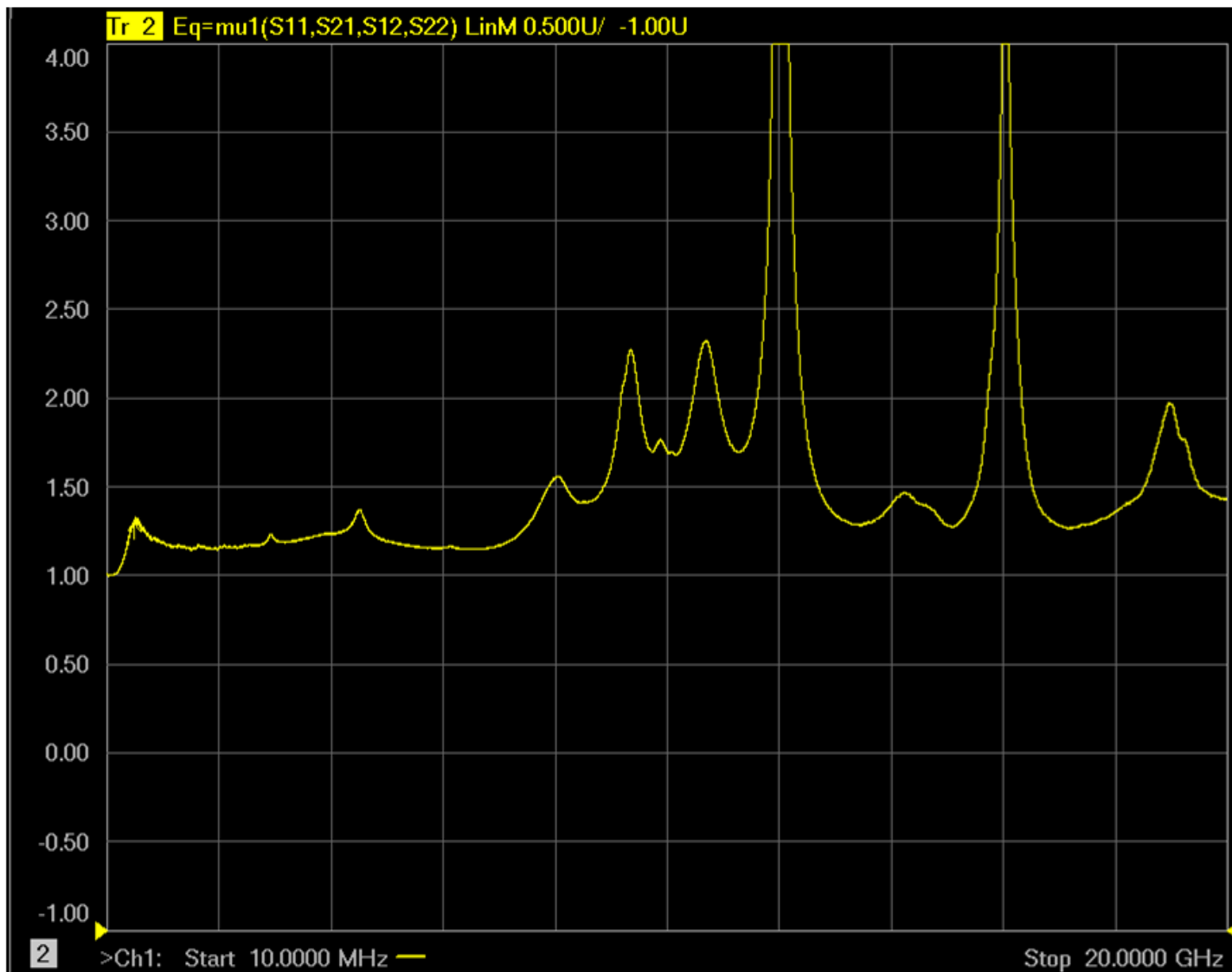

Note: Mu Factor ≥ 1.0 implies unconditional stability.

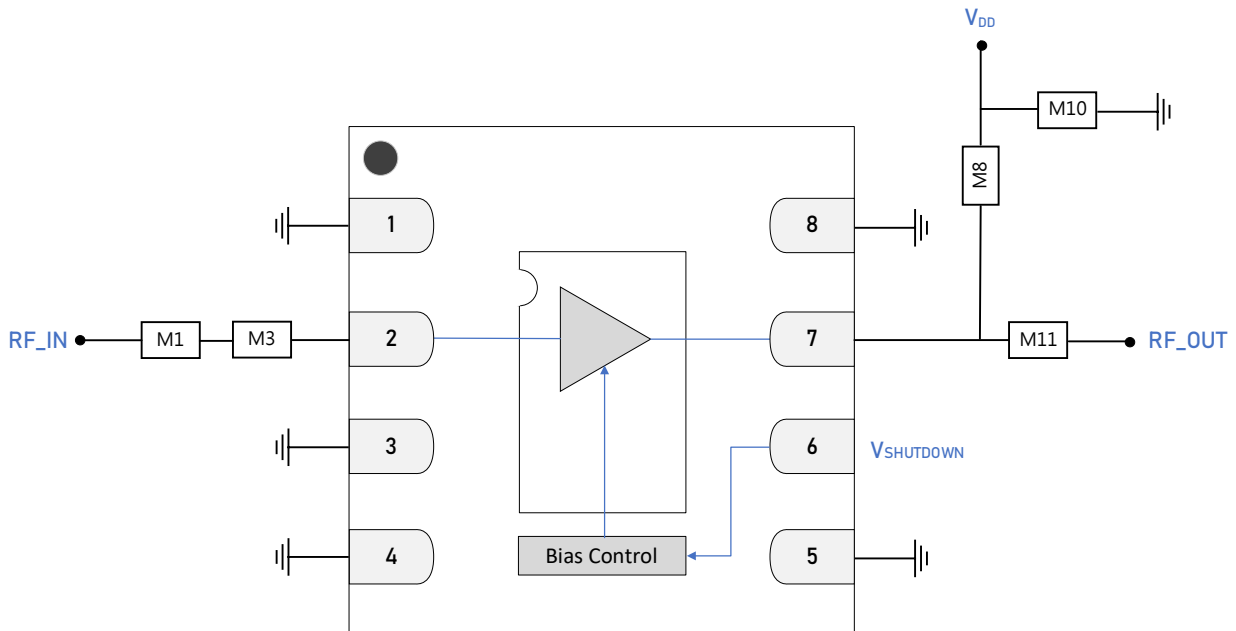

GRF2080 Standard Test Schematic

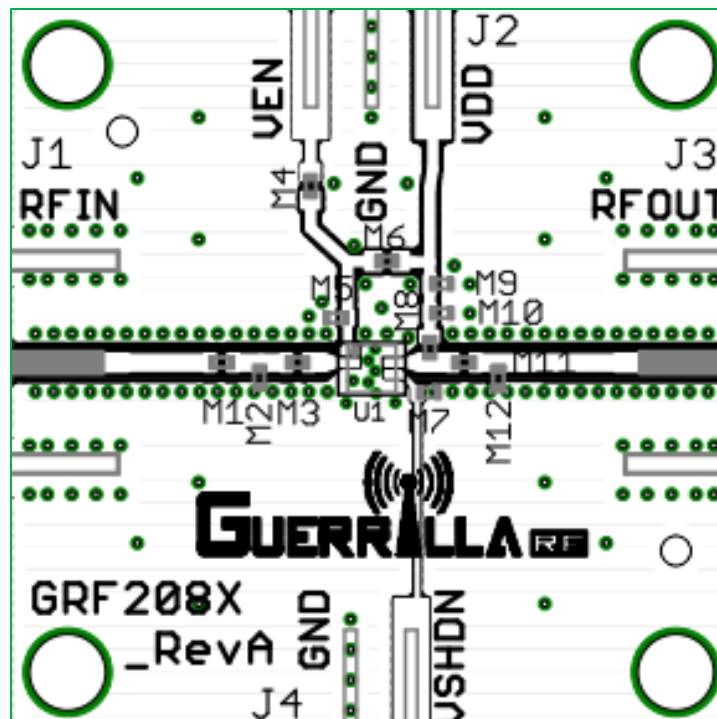

GRF2080 Evaluation Board Assembly Diagram

GRF2080 Evaluation Board Assembly Diagram Reference: 0.7 to 1 GHz Tune

Component	Type	Manufacturer	Family	Value	Package Size	Substitution
M1	Resistor (jumper)	Various	5%	0 Ω	0402	ok
M3	Capacitor	Murata	GJM	47 pF	0402	ok (high Q)
M8	Inductor	Murata	LQG	22 nH	0402	ok
M10	Capacitor	Murata	GRM	0.1 μ F	0402	ok
M11	Capacitor	Murata	GRM	4.7 pF	0402	ok
Evaluation Board	GRF208X_RevA					

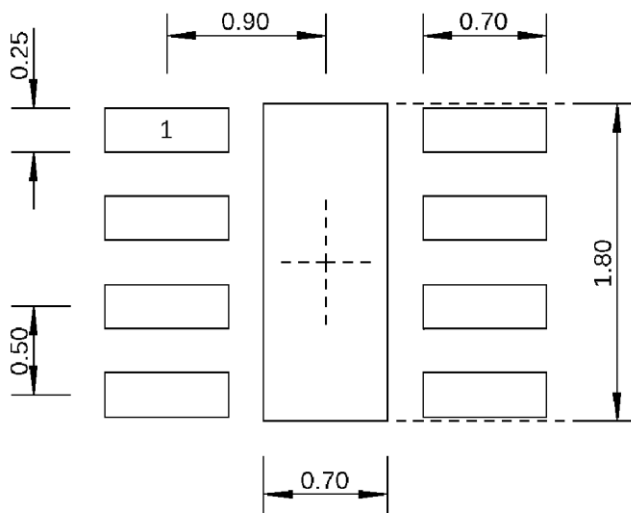

Dimensions in millimeters

2.0 x 2.0 mm DFN-8 Suggested PCB Footprint (Top View)

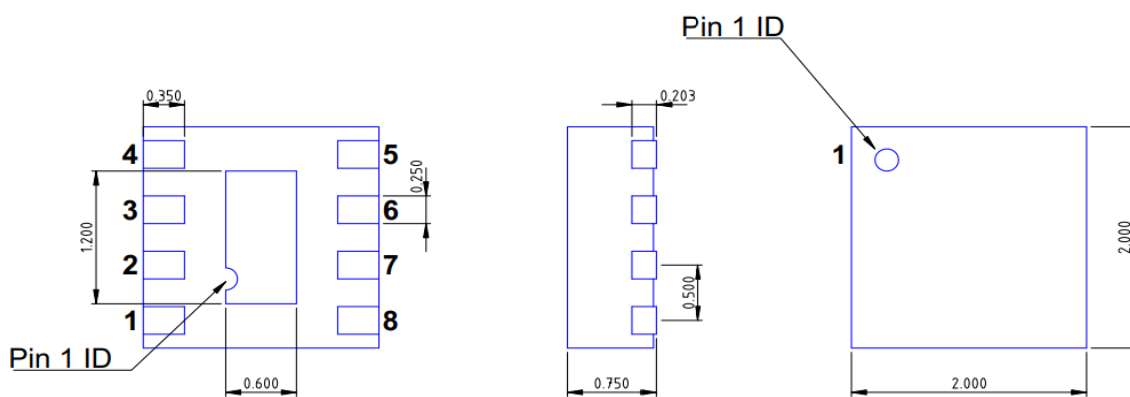

Bottom View

Side View

Top View

DFN8_2X2MM
 Dimensions in millimeters
 Dimensional Tolerance: ± 0.05

2.0 x 2.0 mm DFN-8 Package Dimensions

Package Marking Diagram



Line 1: "Y" = YEAR (single digit). "WW" = WORK WEEK the device was assembled.

Line 2: "XXXX" = Device PART NUMBER.

Tape and Reel Information

Guerrilla RF's tape and reel specification complies with Electronics Industries Association (EIA) standards for "Embossed Carrier Tape of Surface Mount Components for Automatic Handling" (reference EIA-481). See the following page for the Tape and Reel Specification and Device Package Information table, which includes units per reel.

Devices are loaded with pins down into the carrier pocket with protective cover tape and reeled onto a plastic reel. Each reel is packaged in a cardboard box. There are product labels on the reel, the protective ESD bag and the outside surface of the box.

For the Tape and Reel Reference Table, please refer to: [Package Manufacturing Information | Guerrilla RF \(guerrilla-rf.com\)](https://www.guerrilla-rf.com)

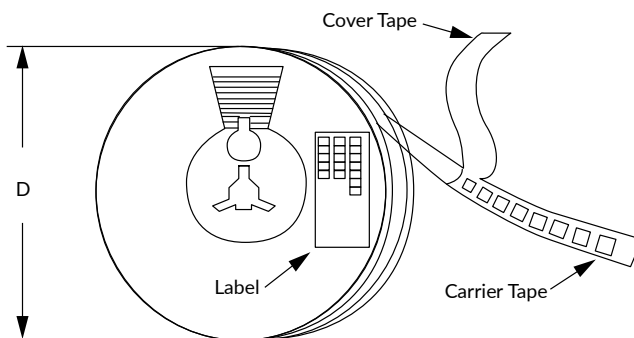

Tape and Reel Packaging with Reel Diameter Noted (D)

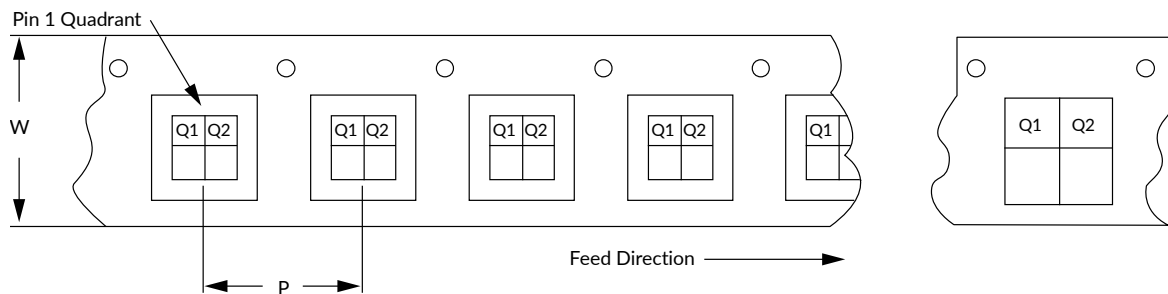

Carrier Tape Width (W), Pitch (P), Feed Direction and Pin 1 Quadrant Information



Revision History

Revision Date	Description of Change
May 4, 2023	Upgraded to new format.



Data Sheet Classifications

Data Sheet Status	Notes
Advance	S-Parameter and NF data based on EM simulations for the fully packaged device using foundry-supplied transistor S-Parameters. Linearity estimates based on device size, bias condition and experience with related devices.
Preliminary	All data based on limited evaluation board measurements taken within the Guerrilla RF Applications Lab. All parametric values are subject to change pending the collection of additional data.
Release Ø	All data based on measurements taken with <i>production-released</i> material. TYP values are based on a combination of ATE and bench-level measurements, with MIN/MAX limits defined using <i>modelled estimates</i> that account for part-to-part variations and expected process spreads. Although unlikely, future refinements to the TYP/MIN/MAX values may be in order as multiple lots are processed through the factory.
Release A-Z	All data based on measurements taken with production-released material <i>derived from multiple lots which have been fabricated over an extended period of time</i> . MIN/MAX limits may be refined over previous releases as more statistically significant data is collected to account for process spreads.

Information in this data sheet is specific to the Guerrilla RF, Inc. ("Guerrilla RF") product identified.

This data sheet, including the information contained in it, is provided by Guerrilla RF as a service to its customers and may be used for informational purposes only by the customer. Guerrilla RF assumes no responsibility for errors or omissions on this data sheet or the information contained herein. Information provided is believed to be accurate and reliable, however, no responsibility is assumed by Guerrilla RF for its use, nor for any infringement of patents, or other rights of third parties, resulting from its use. Guerrilla RF assumes no liability for any data sheet, data sheet information, materials, products, product information, or other information provided hereunder, including the sale, distribution, reproduction or use of Guerrilla RF products, information or materials.

No license, whether express, implied, by estoppel, by implication or otherwise is granted by this data sheet for any intellectual property of Guerrilla RF, or any third party, including without limitation, patents, patent rights, copyrights, trademarks and trade secrets. All rights are reserved by Guerrilla RF.

All information herein, products, product information, data sheets, and data sheet information are subject to change and availability without notice. Guerrilla RF reserves the right to change component circuitry, recommended application circuitry and specifications at any time without prior notice. Guerrilla RF may further change its data sheet, product information, documentation, products, services, specifications or product descriptions at any time, without notice. Guerrilla RF makes no commitment to update any materials or information and shall have no responsibility whatsoever for conflicts, incompatibilities, or other difficulties arising from any future changes.

GUERRILLA RF INFORMATION, PRODUCTS, PRODUCT INFORMATION, DATA SHEETS AND DATA SHEET INFORMATION ARE PROVIDED "AS IS" AND WITHOUT WARRANTY OF ANY KIND, WHETHER EXPRESS, IMPLIED, STATUTORY, OR OTHERWISE, INCLUDING FITNESS FOR A PARTICULAR PURPOSE OR USE, MERCHANTABILITY, PERFORMANCE, QUALITY OR NON-INFRINGEMENT OF ANY INTELLECTUAL PROPERTY RIGHT; ALL SUCH WARRANTIES ARE HEREBY EXPRESSLY DISCLAIMED. GUERRILLA RF DOES NOT WARRANT THE ACCURACY OR COMPLETENESS OF THE INFORMATION, TEXT, GRAPHICS OR OTHER ITEMS CONTAINED WITHIN THESE MATERIALS. GUERRILLA RF SHALL NOT BE LIABLE FOR ANY DAMAGES, INCLUDING BUT NOT LIMITED TO ANY SPECIAL, INDIRECT, INCIDENTAL, STATUTORY, OR CONSEQUENTIAL DAMAGES, INCLUDING WITHOUT LIMITATION, LOST REVENUES OR LOST PROFITS THAT MAY RESULT FROM THE USE OF THE MATERIALS OR INFORMATION, WHETHER OR NOT THE RECIPIENT OF MATERIALS HAS BEEN ADVISED OF THE POSSIBILITY OF SUCH DAMAGE.

Customers are solely responsible for their use of Guerrilla RF products in the Customer's products and applications or in ways which deviate from Guerrilla RF's published specifications, either intentionally or as a result of design defects, errors, or operation of products outside of published parameters or design specifications. Customers should include design and operating safeguards to minimize these and other risks. Guerrilla RF assumes no liability or responsibility for applications assistance, customer product design, or damage to any equipment resulting from the use of Guerrilla RF products outside of stated published specifications or parameters.