



GRF2073

Ultra-Low Noise Amplifier 2 to 6 GHz

FEATURES

- Excellent NF Performance
- High Gain
- Outstanding Linearity
- Flexible Bias Voltage and Current
- Compact 2.0 x 2.0 mm DFN-8 Package
- Process: GaAs pHEMT

Reference: 5 V / 70 mA / 3.6 GHz

- Gain: 18.5 dB
- OIP3: 35 dBm
- OP1dB: 18 dBm
- Evaluation Board Noise Figure: 0.65 dB

APPLICATIONS

- Cellular Infrastructure
- Small Cells and Cellular Repeaters
- Distributed Antenna Systems
- C-Band LNA to 6 GHz
- 3.5 GHz CBRS
- TDD-LTE

DESCRIPTION

The GRF2073 is a broadband, linear, ultra-low Noise amplifier designed for small cell, wireless infrastructure, and other high performance RF applications requiring ultra-low NF, high Gain, and linearity.

This device is a member of a family of pin-compatible, ultra-low Noise devices which cover a wide range of frequency bands with industry leading NF and Gain:

GRF2070: 0.1 to 1.5 GHz **GRF2071:** 0.7 to 2.7 GHz

GRF2072: 1.5 to 3.8 GHz **GRF2073:** 2.0 to 6.0 GHz

GRF2074: 1.0 to 6.0 GHz (Next-gen Process)

Please consult with the GRF applications engineering team for application notes and custom tuning/evaluation board data. De-embedded S-Parameters with Noise Parameters are available on the website.

BLOCK DIAGRAM

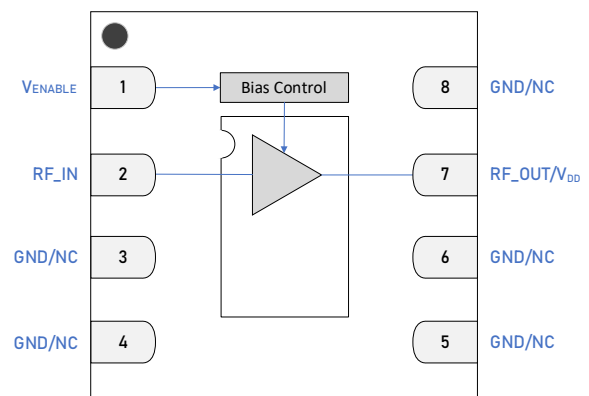

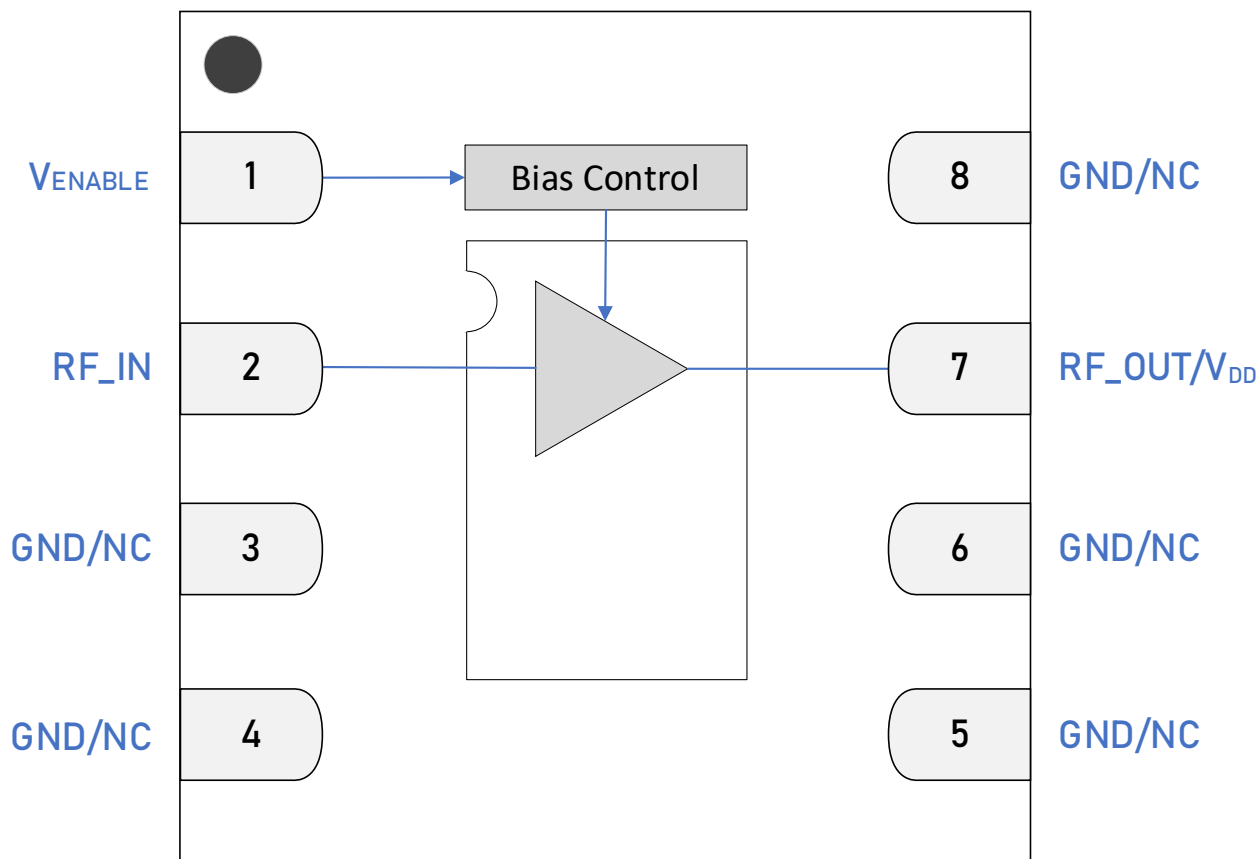

2.0 x 2.0 mm DFN-8 Pin Out (Top View)

Pin Assignments

Pin	Name	Description	Note
1	V _{ENABLE}	Enable Voltage Input	V _{ENABLE} and series resistor set I _{DDQ} . V _{ENABLE} ≤ 0.2 volts disables device.
2	RF_IN	RF Input	External match must provide DC block.
3, 4, 5, 6, 8	GND/NC	Ground or No Connect	No internal connection to die. We recommend connecting these pins to GND.
7	RF_Out/V _{DD}	RF Output	Provide device V _{DD} via external bias inductor.
PKG BASE	GND	Ground	Provides DC and RF ground for LNA, as well as thermal heat sink. Recommend multiple 8 mil vias beneath the package for optimal RF and thermal performance. Refer to evaluation board top layer graphic on schematic page.

Absolute Ratings

Parameter	Symbol	Min.	Max.	Unit
Supply Voltage	V_{DD}	0	6	V
RF Input Power (CW, Load VSWR < 2:1, $V_{DD} = 5$ V)	$P_{IN\ MAX}$		23	dBm
Operating Temperature (Package Heat Sink)	$T_{PKG\ HEAT\ SINK}$	-40	105	°C
Maximum Channel Temperature (MTTF > 10 ⁶ Hours)	T_{MAX}		170	°C
Maximum Dissipated Power	$P_{DISS\ MAX}$		500	mW

Electrostatic Discharge

Charged Device Model	CDM	1500		V
Human Body Model	HBM	500		V

Storage

Storage Temperature	T_{STG}	-65	150	°C
Moisture Sensitivity Level	MSL		1	--



Caution! ESD Sensitive Device.

Exceeding Absolute Maximum Rating conditions may cause permanent damage.

Note: For additional information, please refer to *Manufacturing Note MN-001 — Package and Manufacturing Information*.



All Guerrilla RF products are provided in RoHS compliant lead (Pb)-free packaging requiring no exemptions. Additional information for this topic can be found at this link - [Environmental and Restricted Substance Statement Library](#)

Recommended Operating Conditions

Parameter	Symbol	Specification			Unit	Condition
		Min.	Typ.	Max.		
Supply Voltage	V_{DD}	0	5	6	V	
Operating Temperature (Package Heat Sink)	$T_{PKG \text{ HEAT SINK}}$	-40		105	°C	
RF Frequency Range	F_{RF}	2	3.6	6	GHz	Typical Application Schematic with external matching components (note 1 & 2).
RF_IN Port Impedance	Z_{RFIN}		50		Ω	Single Ended.
RF_Out Port Impedance	Z_{RFOUT}		50		Ω	Single Ended.

Note 1: Operation outside of this range is possible, but with degraded performance of some parameters.

Note 2: Contact the Guerrilla RF Applications team for guidance on optimizing the tuning of the device for alternative bands.

Nominal Operating Parameters – General

The following conditions apply unless noted otherwise: Typical Application Schematic using the 2 to 6 GHz tuning set. $V_{DD} = 5\text{ V}$, $V_{ENABLE} = 5\text{ V}$, $I_{DD} = 70\text{ mA}$, $M3 = 1.07\text{ k}\Omega$, $F_{TEST} = 3.6\text{ GHz}$. $T_{PKG\ HEAT\ SINK} = 25\text{ }^{\circ}\text{C}$. Evaluation board losses are included within the specifications.

Parameter	Symbol	Specification			Unit	Condition
		Min.	Typ.	Max.		
Supply Current	I_{DD}	50	70	90	mA	$V_{DD} = 5\text{ V}$, $V_{ENABLE} = 5\text{ V}$.
Enable Current	I_{ENABLE}		3.5		mA	
Switching Rise Time	T_{RISE}		300		ns	
Switching Fall Time	T_{FALL}		300		ns	

Thermal Data

Thermal Resistance (Infrared Scan)	Θ_{JC}		60		$^{\circ}\text{C}/\text{W}$	On standard evaluation board (note 3).
------------------------------------	---------------	--	----	--	-----------------------------	---

Note 3: $MTTF > 10^6$ hours for $T_{CHANNEL} \leq 170\text{ }^{\circ}\text{C}$.

Nominal Operating Parameters – RF

The following conditions apply unless noted otherwise: Typical Application Schematic using the 2 to 6 GHz tuning set. $V_{DD} = 5\text{ V}$, $V_{ENABLE} = 5\text{ V}$, $I_{DD} = 70\text{ mA}$, $M3 = 1.07\text{ k}\Omega$, $F_{TEST} = 3.6\text{ GHz}$. $T_{PKG\ HEAT\ SINK} = 25\text{ }^{\circ}\text{C}$. MIN/MAX specifications listed in italics are guaranteed via production test screening. All other parameters are guaranteed by design and characterization. Evaluation board losses are included within the specifications.

Parameter	Symbol	Specification			Unit	Condition
		Min.	Typ.	Max.		
Gain	S21	<i>17.5</i>	18.5		dB	
Reverse Isolation	S12		-24		dB	$F_{RF} = 3.4\text{ to }3.8\text{ GHz}$.
Evaluation Board Noise Figure	NF		0.65	0.85	dB	Evaluation Board SMA to SMA.
Output 3 rd Order Intercept Point	OIP3		35		dBm	+3 dBm P_{OUT} per tone at 2 MHz spacing (3599 and 3601 MHz).
Output 1 dB Compression Power	OP1dB	<i>16.5</i>	18		dBm	

Typical Operating Curve Conditions

The following conditions apply unless noted otherwise: Typical Application Schematic using the 2 to 6 GHz tuning set. $V_{DD} = 5\text{ V}$, $V_{ENABLE} = 5\text{ V}$, $I_{DD} = 70\text{ mA}$, $M3 = 1.07\text{ k}\Omega$, $F_{TEST} = 3.6\text{ GHz}$. $T_{PKG\ HEAT\ SINK} = 25\text{ }^{\circ}\text{C}$. Evaluation board losses are included within the plots.

GRF2073 Typical Operating Curves

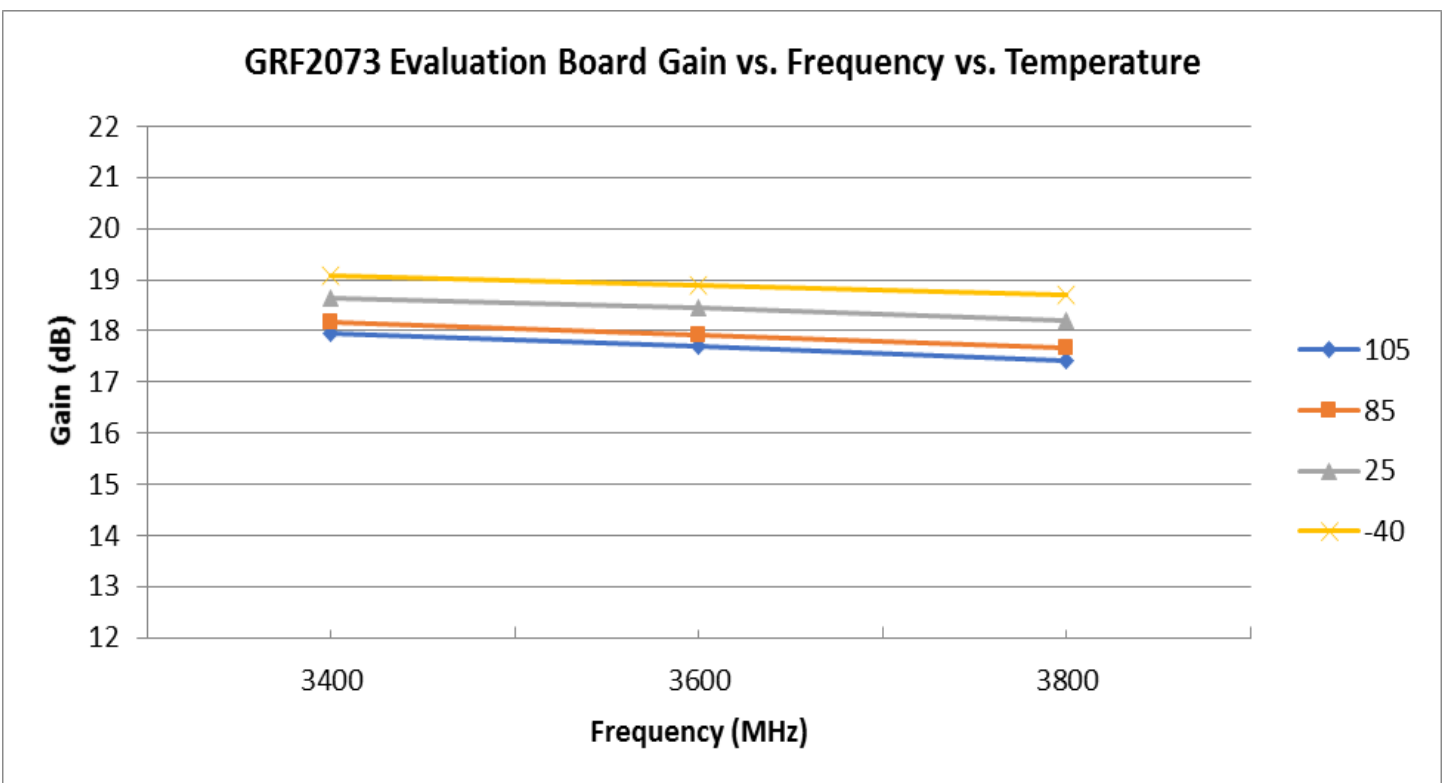
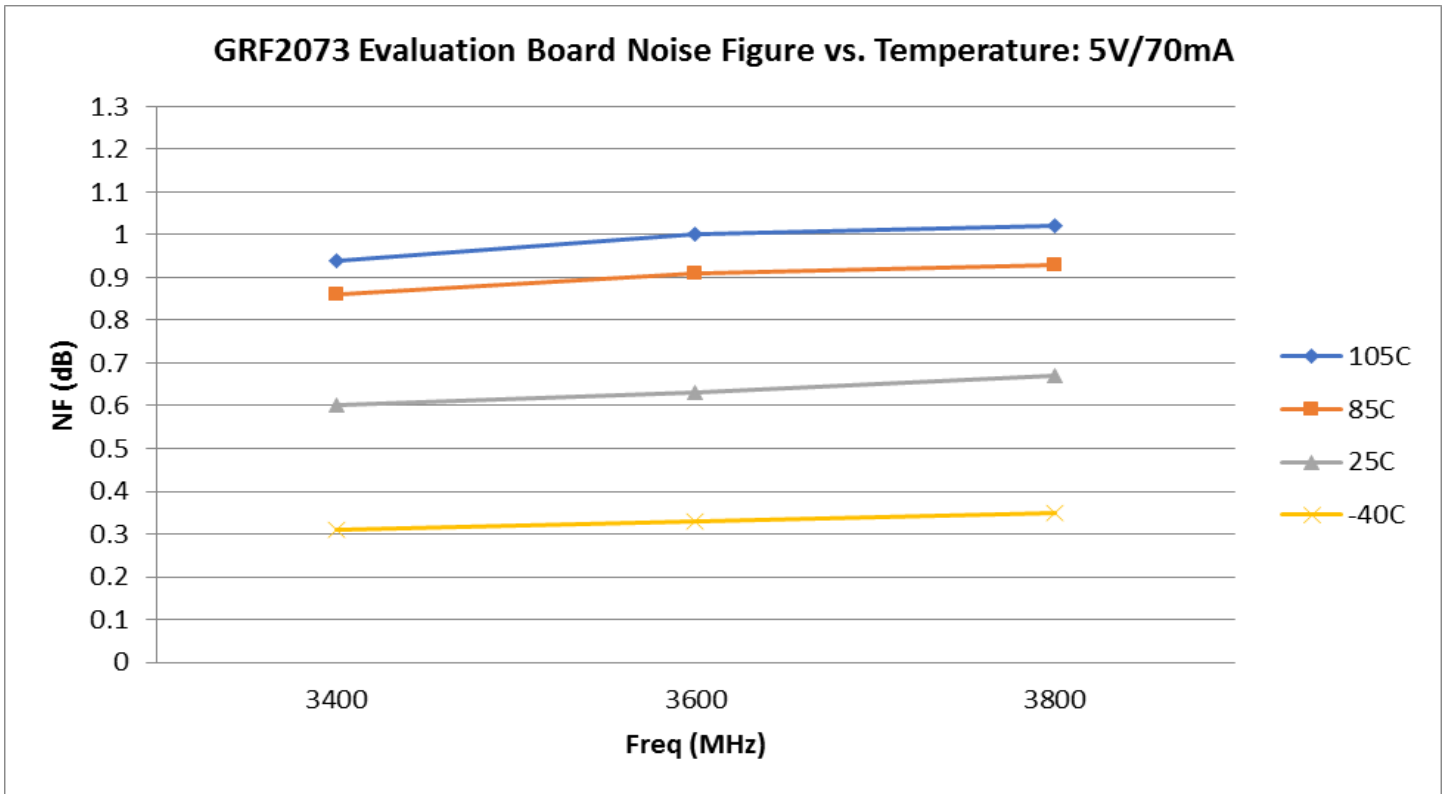

GRF2073 Typical Operating Curves

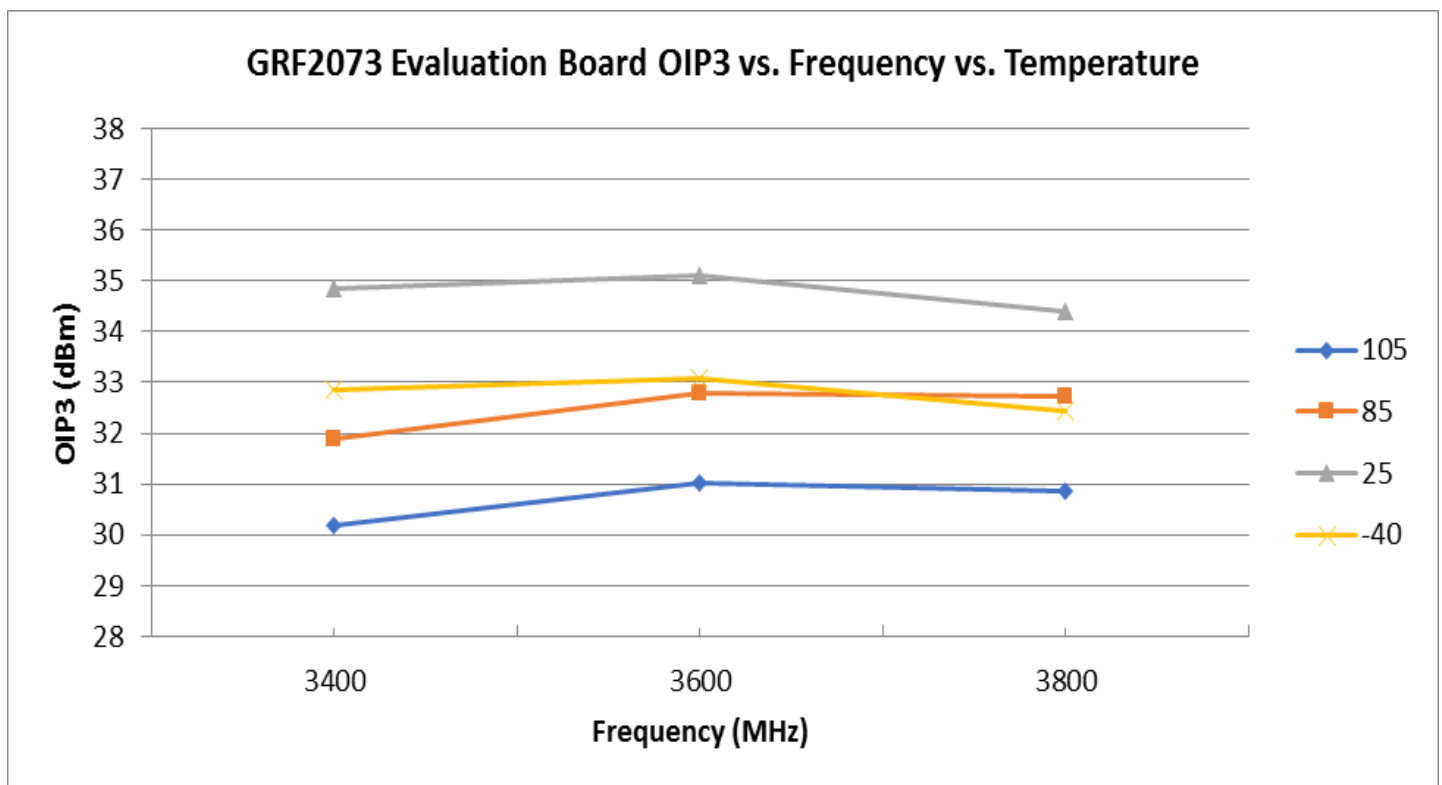
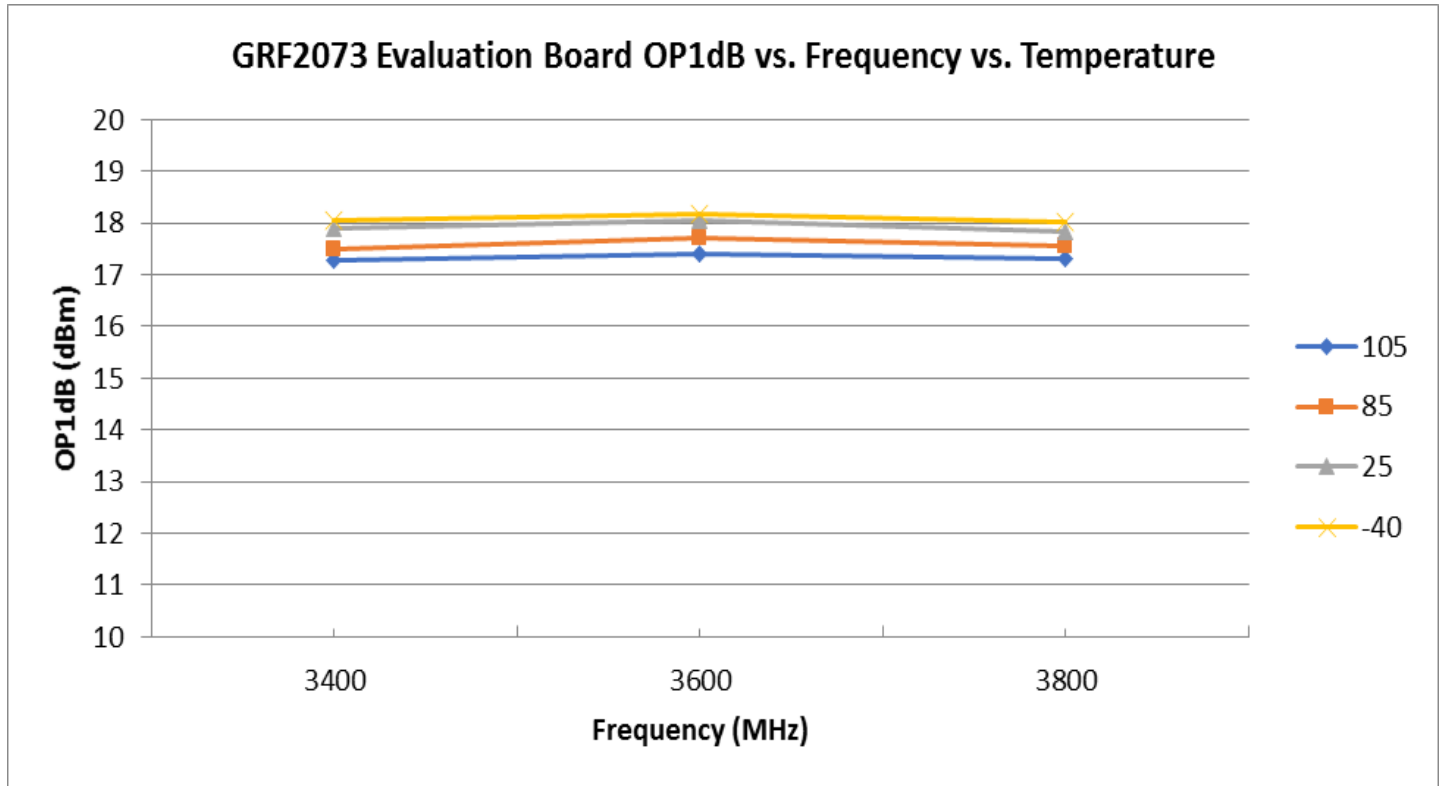

GRF2073 Typical Operating Curves: S-Parameters (3.4 to 3.8 GHz Tune)

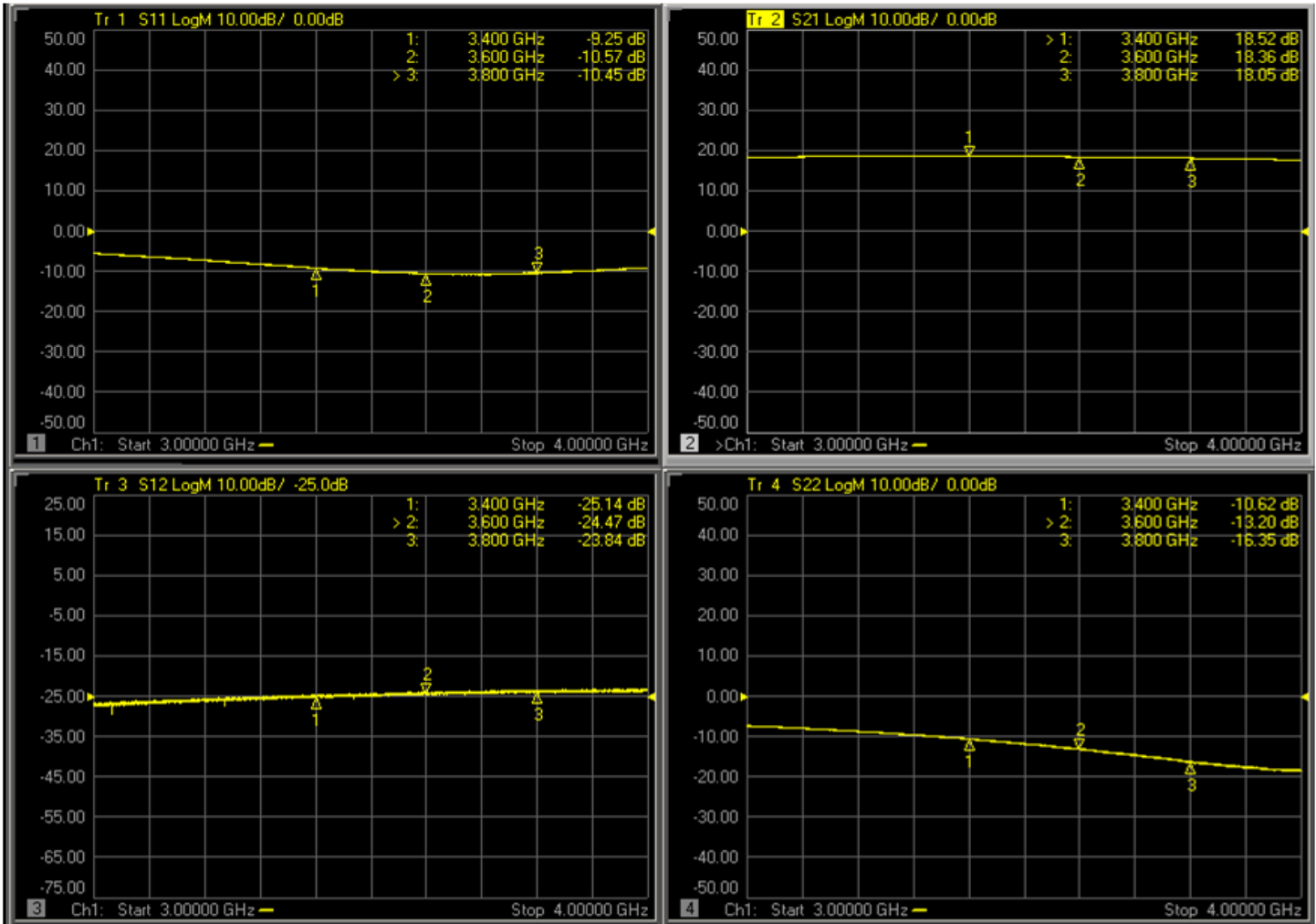

GRF2073 Typical Operating Curves: Stability Mu (3.4 to 3.8 GHz Tune)

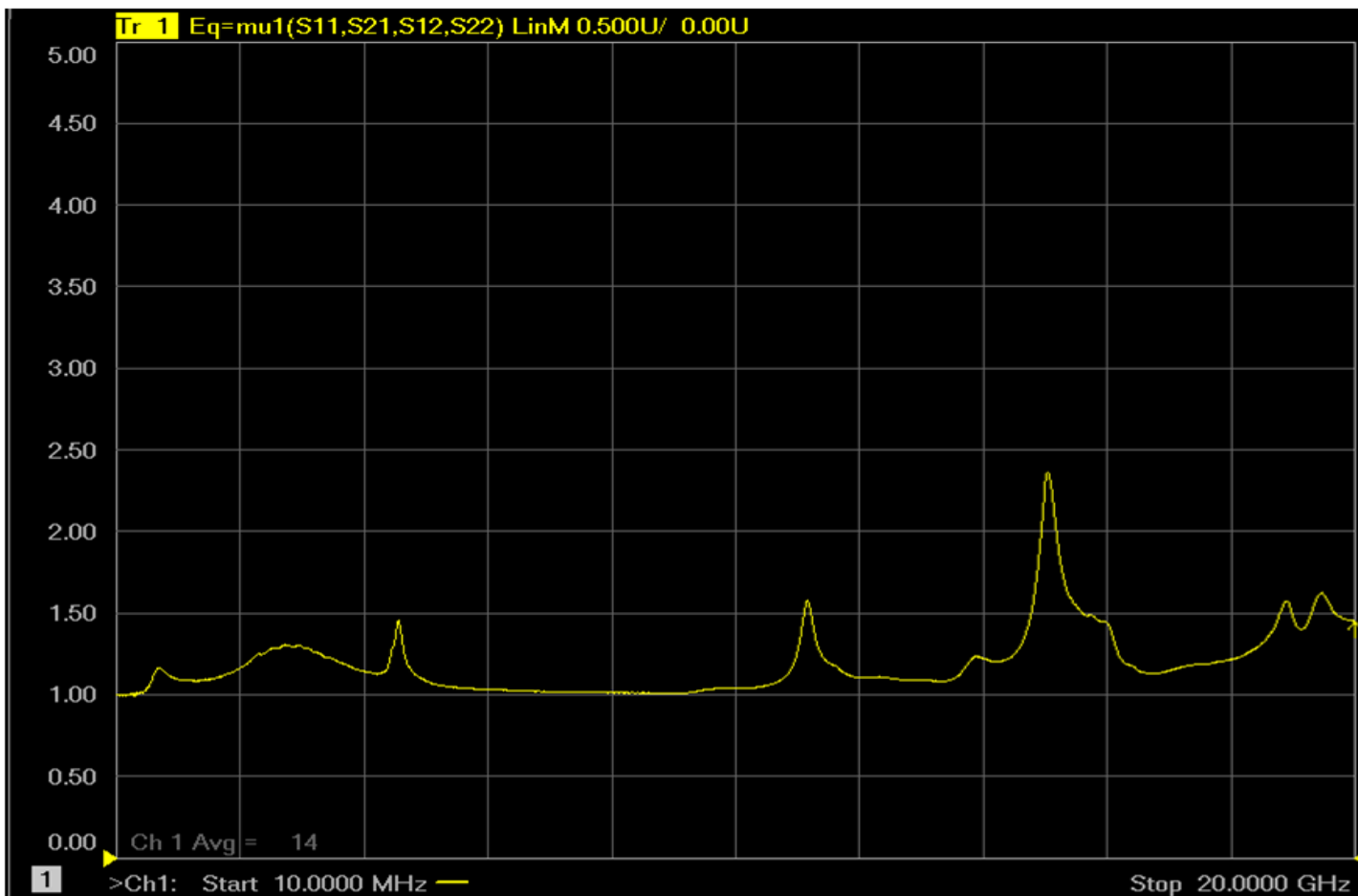

Note: $\mu \geq 1.0$ implies unconditional stability.

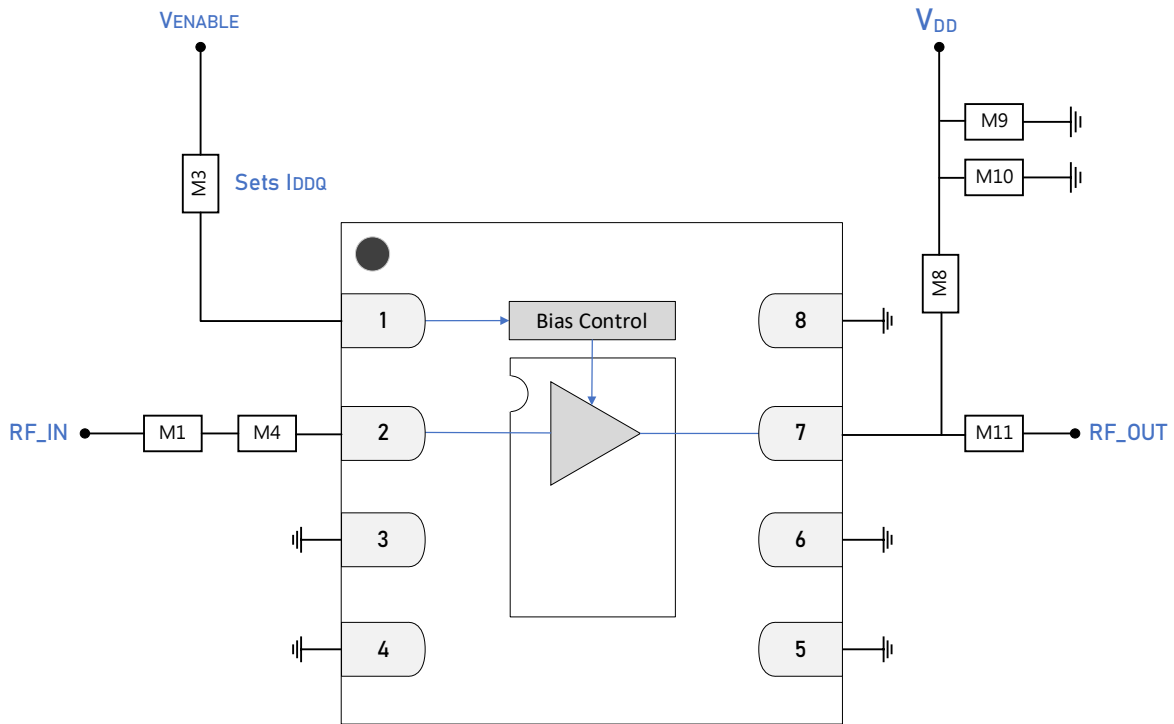

GRF2073 Standard Test Schematic

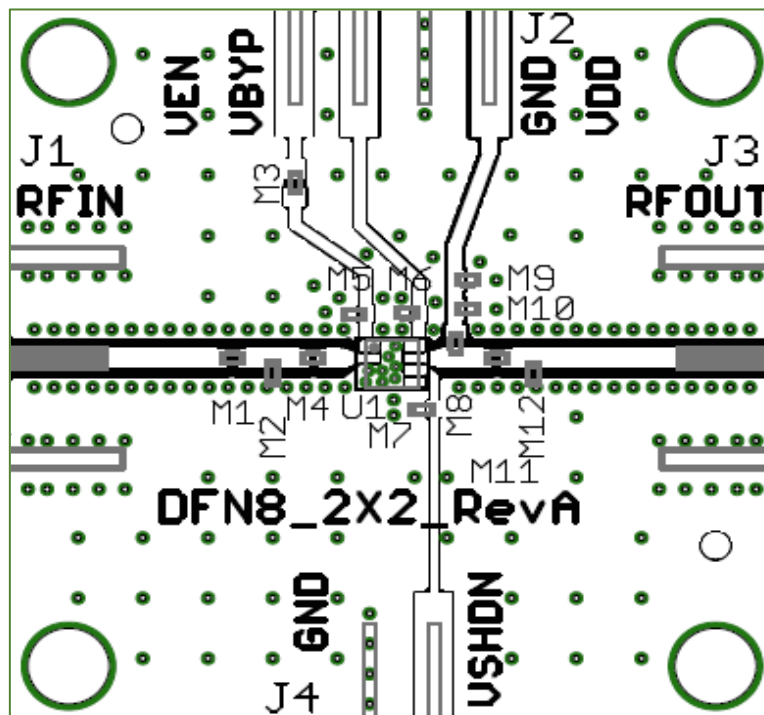

GRF2073 Evaluation Board Assembly Diagram

GRF2073 Evaluation Board Assembly Diagram Reference: 3.4 to 3.8 GHz Tune

Component	Type	Manufacturer	Family	Value	Package Size	Substitution
M1	Capacitor	Murata	GJM	1.2 pF	0402	ok (High Q)
M3 (sets I _{DDQ})	Resistor	Various	5%	See Curves	0402	ok
M4	Resistor	Various	--	0 Ω	0402	ok
M8	Inductor	Murata	LQG	1.8 nH	0402	ok
M9	Capacitor	Murata	GRM	0.1 μF	0402	ok
M10	Capacitor	Murata	GRM	100 pF	0402	ok
M11	Capacitor	Murata	GJM	5.1 pF	0402	ok
Evaluation Board	DFN8_2x2_RevA					

GRF2073 Bias Resistor Selection Curves

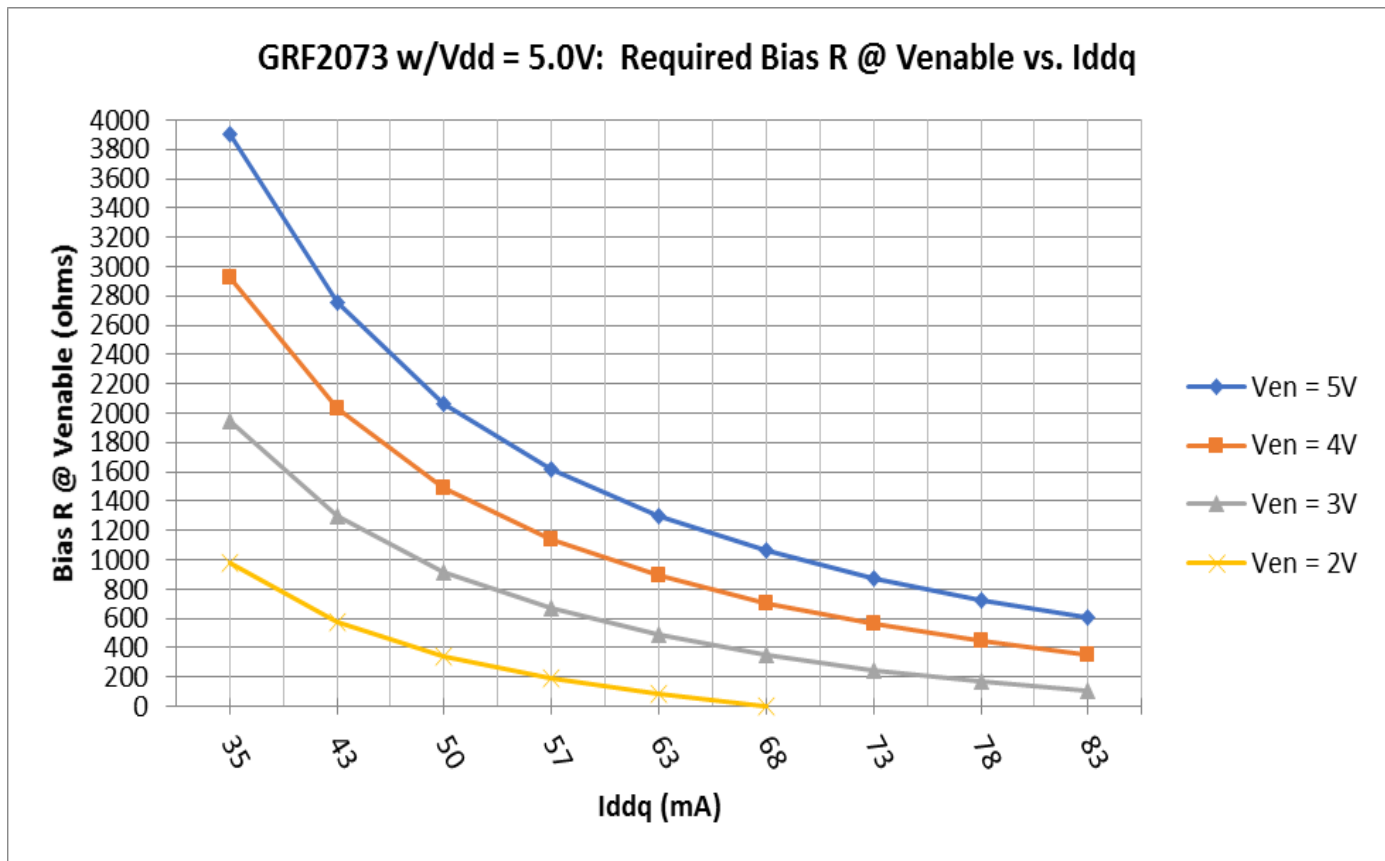

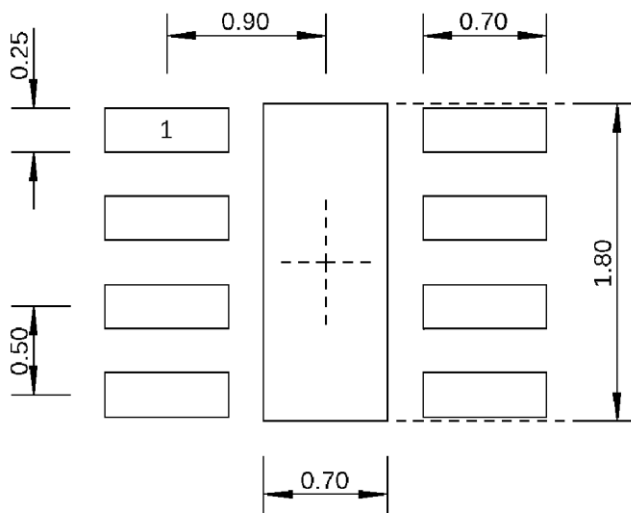

Dimensions in millimeters

2.0 x 2.0 mm DFN-8 Suggested PCB Footprint (Top View)

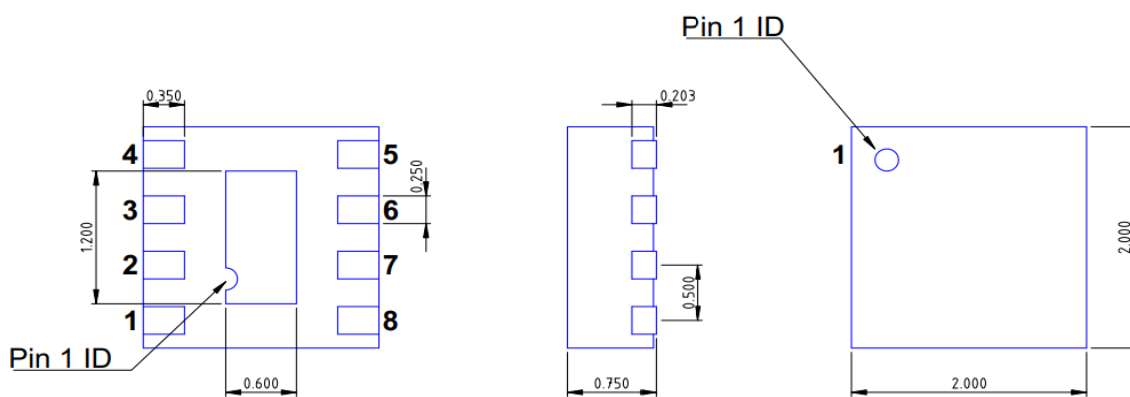

Bottom View

Side View

Top View

DFN8_2X2MM
 Dimensions in millimeters
 Dimensional Tolerance: ± 0.05

2.0 x 2.0 mm DFN-8 Package Dimensions

Package Marking Diagram



- Line 1: "Y" = YEAR (single digit). "WW" = WORK WEEK the Device was assembled.
- Line 2: "XXXX" = Device PART NUMBER.

Tape and Reel Information

Guerrilla RF's tape and reel specification complies with Electronics Industries Association (EIA) standards for "Embossed Carrier Tape of Surface Mount Components for Automatic Handling" (reference EIA-481). See the following page for the Tape and Reel Specification and Device Package Information table, which includes units per reel.

Devices are loaded with pins down into the carrier pocket with protective cover tape and reeled onto a plastic reel. Each reel is packaged in a cardboard box. There are product labels on the reel, the protective ESD bag and the outside surface of the box.

For the Tape and Reel Reference Table, please refer to: [Package Manufacturing Information | Guerrilla RF \(guerrilla-rf.com\)](#)

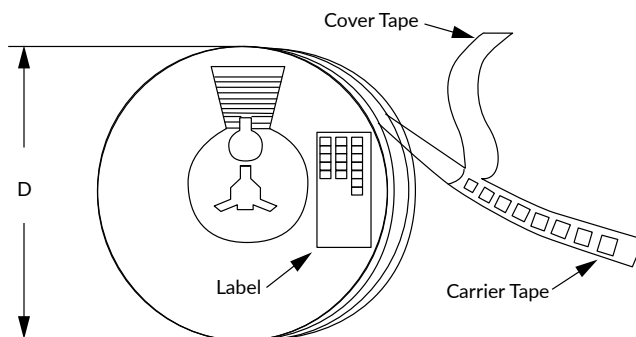

Tape and Reel Packaging with Reel Diameter Noted (D)

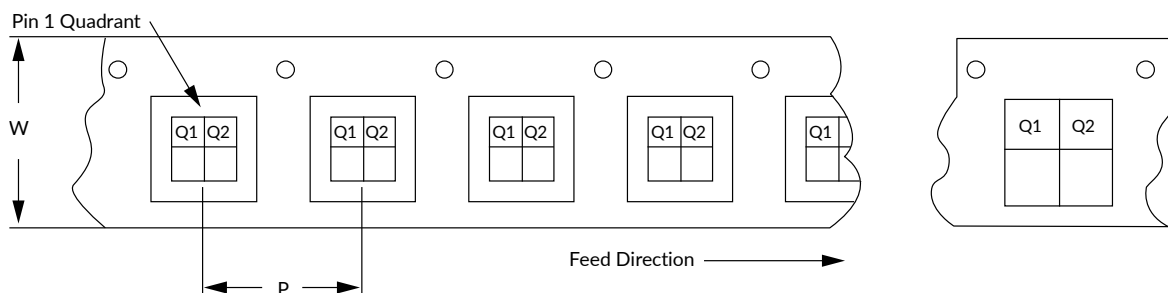

Carrier Tape Width (W), Pitch (P), Feed Direction and Pin 1 Quadrant Information



Revision History

Revision Date	Description of Change
August 11, 2022	Converted format to new template.
May 24, 2023	Upgraded to Release B Data Sheet. Added Supply Current (I _{DD}) Min/Max Limits to match Production Test Plan.



Data Sheet Classifications

Data Sheet Status	Notes
Advance	S-parameter and NF data based on EM simulations for the fully packaged device using foundry-supplied transistor S-parameters. Linearity estimates based on device size, bias condition and experience with related devices.
Preliminary	All data based on limited evaluation board measurements taken within the Guerrilla RF Applications Lab. All parametric values are subject to change pending the collection of additional data.
Release Ø	All data based on measurements taken with <i>production-released</i> material. TYP values are based on a combination of ATE and bench-level measurements, with MIN/MAX limits defined using <i>modelled estimates</i> that account for part-to-part variations and expected process spreads. Although unlikely, future refinements to the TYP/MIN/MAX values may be in order as multiple lots are processed through the factory.
Release A-Z	All data based on measurements taken with production-released material <i>derived from multiple lots which have been fabricated over an extended period of time</i> . MIN/MAX limits may be refined over previous releases as more statistically significant data is collected to account for process spreads.

Information in this data sheet is specific to the Guerrilla RF, Inc. ("Guerrilla RF") product identified.

This data sheet, including the information contained in it, is provided by Guerrilla RF as a service to its customers and may be used for informational purposes only by the customer. Guerrilla RF assumes no responsibility for errors or omissions on this data sheet or the information contained herein. Information provided is believed to be accurate and reliable, however, no responsibility is assumed by Guerrilla RF for its use, nor for any infringement of patents, or other rights of third parties, resulting from its use. Guerrilla RF assumes no liability for any data sheet, data sheet information, materials, products, product information, or other information provided hereunder, including the sale, distribution, reproduction or use of Guerrilla RF products, information or materials.

No license, whether express, implied, by estoppel, by implication or otherwise is granted by this data sheet for any intellectual property of Guerrilla RF, or any third party, including without limitation, patents, patent rights, copyrights, trademarks and trade secrets. All rights are reserved by Guerrilla RF.

All information herein, products, product information, data sheets, and data sheet information are subject to change and availability without notice. Guerrilla RF reserves the right to change component circuitry, recommended application circuitry and specifications at any time without prior notice. Guerrilla RF may further change its data sheet, product information, documentation, products, services, specifications or product descriptions at any time, without notice. Guerrilla RF makes no commitment to update any materials or information and shall have no responsibility whatsoever for conflicts, incompatibilities, or other difficulties arising from any future changes.

GUERRILLA RF INFORMATION, PRODUCTS, PRODUCT INFORMATION, DATA SHEETS AND DATA SHEET INFORMATION ARE PROVIDED "AS IS" AND WITHOUT WARRANTY OF ANY KIND, WHETHER EXPRESS, IMPLIED, STATUTORY, OR OTHERWISE, INCLUDING FITNESS FOR A PARTICULAR PURPOSE OR USE, MERCHANTABILITY, PERFORMANCE, QUALITY OR NON-INFRINGEMENT OF ANY INTELLECTUAL PROPERTY RIGHT; ALL SUCH WARRANTIES ARE HEREBY EXPRESSLY DISCLAIMED. GUERRILLA RF DOES NOT WARRANT THE ACCURACY OR COMPLETENESS OF THE INFORMATION, TEXT, GRAPHICS OR OTHER ITEMS CONTAINED WITHIN THESE MATERIALS. GUERRILLA RF SHALL NOT BE LIABLE FOR ANY DAMAGES, INCLUDING BUT NOT LIMITED TO ANY SPECIAL, INDIRECT, INCIDENTAL, STATUTORY, OR CONSEQUENTIAL DAMAGES, INCLUDING WITHOUT LIMITATION, LOST REVENUES OR LOST PROFITS THAT MAY RESULT FROM THE USE OF THE MATERIALS OR INFORMATION, WHETHER OR NOT THE RECIPIENT OF MATERIALS HAS BEEN ADVISED OF THE POSSIBILITY OF SUCH DAMAGE.

Customers are solely responsible for their use of Guerrilla RF products in the Customer's products and applications or in ways which deviate from Guerrilla RF's published specifications, either intentionally or as a result of design defects, errors, or operation of products outside of published parameters or design specifications. Customers should include design and operating safeguards to minimize these and other risks. Guerrilla RF assumes no liability or responsibility for applications assistance, customer product design, or damage to any equipment resulting from the use of Guerrilla RF products outside of stated published specifications or parameters.