

CCHD-575

Ultra-Low Phase Noise Oscillator

CCHD-575 Model
5×7.5 mm SMD, 3.3V, HCMOS

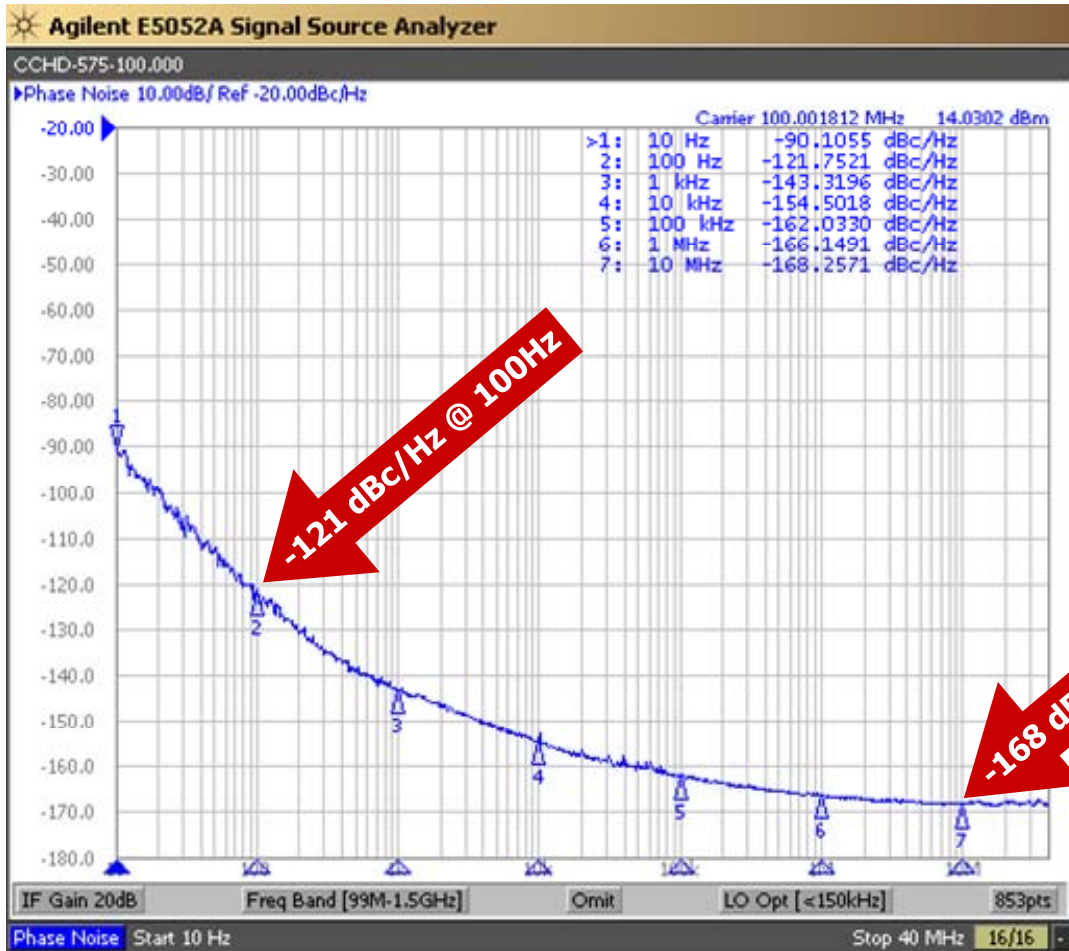
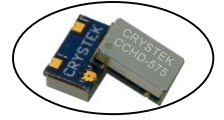

Model CCHD-575 is the industry's lowest jitter clock oscillator in a 5×7.5 mm package. It features a typical phase jitter of 82fs RMS at 100 MHz. Close-in phase noise is -90 dBc/Hz @ 10 Hz while its floor is at -168 dBc/Hz. This oscillator may be small in size but it packs a punch inside. Its output driver is capable of driving ±24mA. This translates to a rise/fall time of ~600ps at 100 MHz with a 15pF load.

Applications include
DACs
ADCs
Low Phase Signal Sources
Test and Measurement

Rev: V
Date: 29-Jun-2020
Page 1 of 5

CCHD-575

Ultra-Low Phase Noise Oscillator



CCHD-575 Model

5x7.5 mm SMD, 3.3V, HCMOS

Frequency Range:	12 MHz to 125 MHz*
Temperature Range:	0°C to +70°C
	-20°C to +70°C (Option M)
	-40°C to +85°C (Option X)
Storage:	-45°C to 90°C
Input Voltage:	3.3V ±0.3V
Input Current:	15mA Typical, 25mA Max
Output:	HCMOS
	45/55% Max @ 50% Vdd
Symmetry:	
Rise/Fall Time:	2ns Max @ 20% to 80% Vdd
Logic:	"0" = 10% Vdd Max
	"1" = 90% Vdd Min
	15pF
Load:	Output Current: ±24mA Max
	82fs RMS Typical @ 100 MHz
Phase Jitter: (12kHz~80MHz)	See plot
Phase Noise Typical:	-168 dBc/Hz Typical, -165 dBc/Hz Max
Phase Noise Floor:	None
Sub-harmonics:	None
Aging:	<3ppm 1 st year, <1ppm thereafter



CCHD-575 Options:	
Temperature Range:	0°C to +70°C (±20ppm, ±25ppm, ±50ppm)
	-20°C to +70°C (±25ppm, ±50ppm)
	-40°C to +85°C (±25ppm, ±50ppm)

Part Number Example:
CCHD-575X-25-100.000 = 3.3V, 45/55, -40°C to +85°C (±25ppm), 100 MHz

RECOMMENDED REFLOW SOLDERING PROFILE

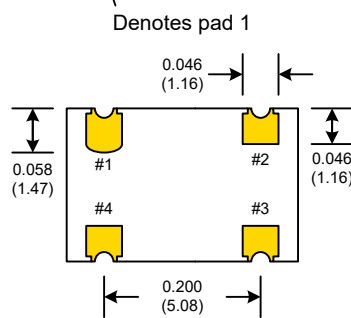
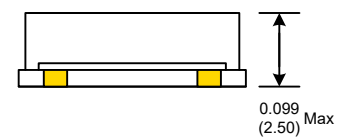
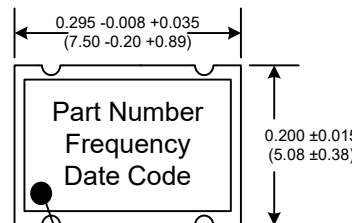
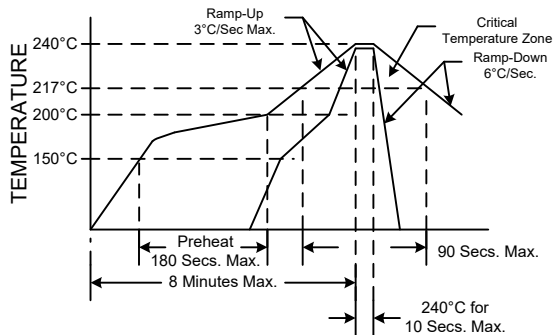

SUGGESTED PAD LAYOUT

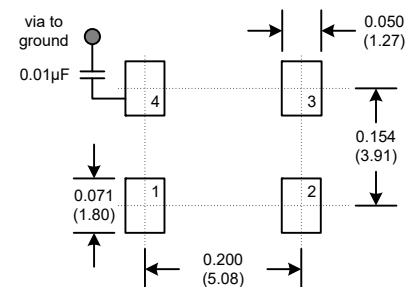

*Standard Frequencies (MHz)	
12.000	48.000
16.924400	49.152
22.579200	50.000
24.000	54.000
24.576	80.000
27.000	100.000
40.000	125.000
45.158400	

Pad	Connection
1	NC
2	GND
3	Output
4	Vdd

PAD FINISH: Immersion Gold (ENIG); 5 micro inches maximum

Rev: V
Date: 29-Jun-2020
Page 2 of 5

Crystek Corporation reserves the right to make changes to its products and/or information contained herein without notice. No liability is assumed as a result of its use or application.

CCHD-575

Ultra-Low Phase Noise Oscillator

CCHD-575 Model
5×7.5 mm SMD, 3.3V, HCMOS

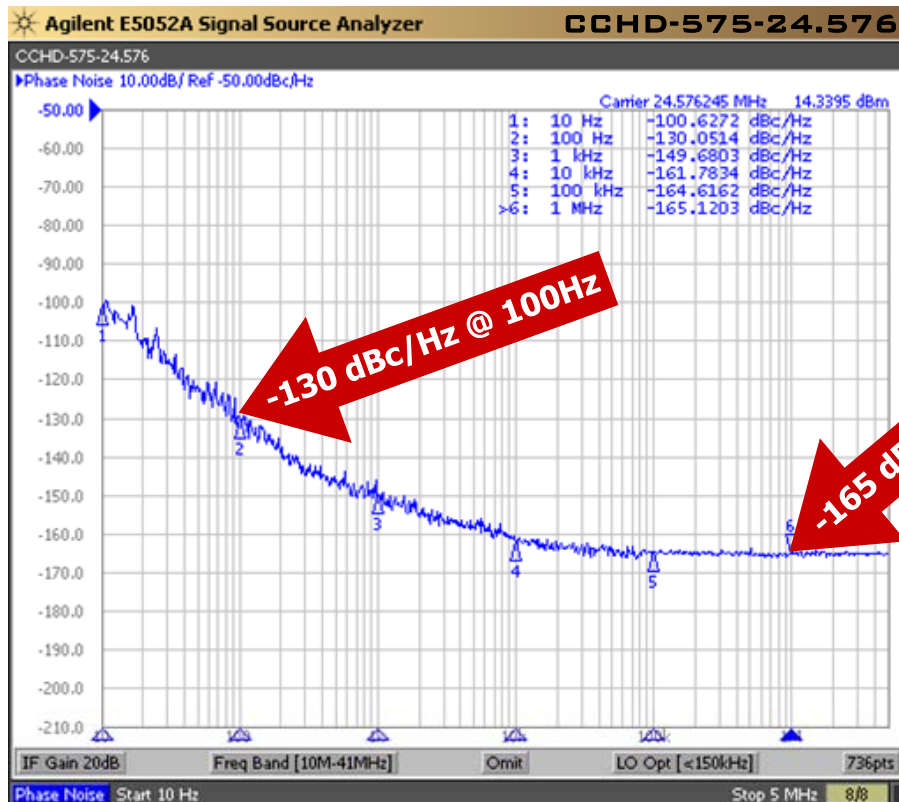
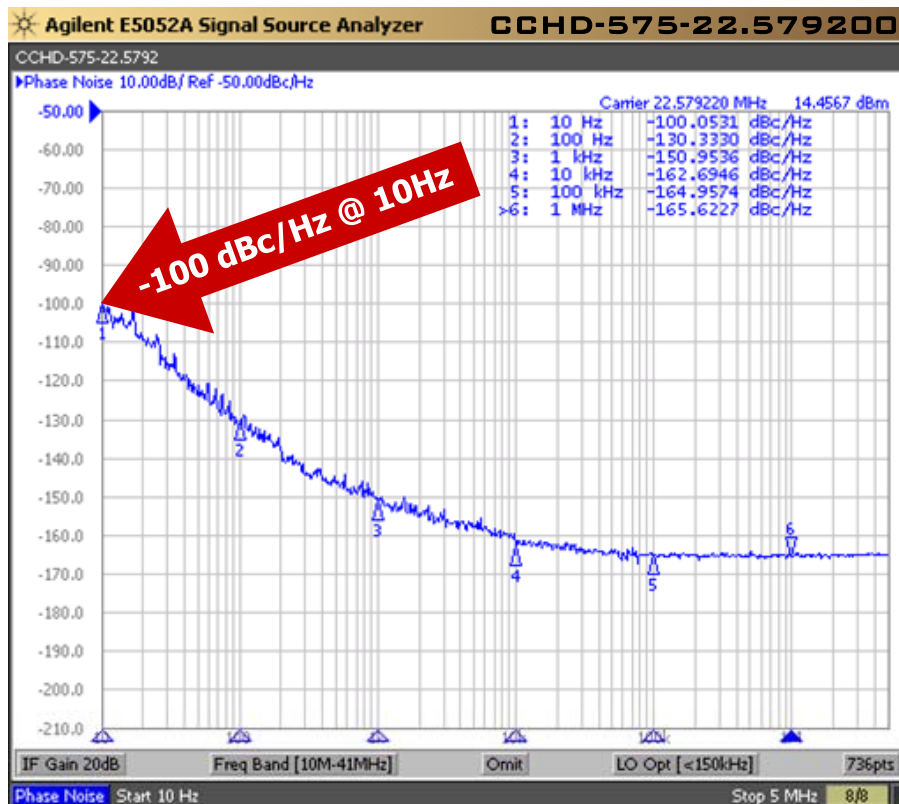

Rev: V
Date: 29-Jun-2020
Page 3 of 5

CCHD-575

Ultra-Low Phase Noise Oscillator

CCHD-575 Model
5×7.5 mm SMD, 3.3V, HCMOS

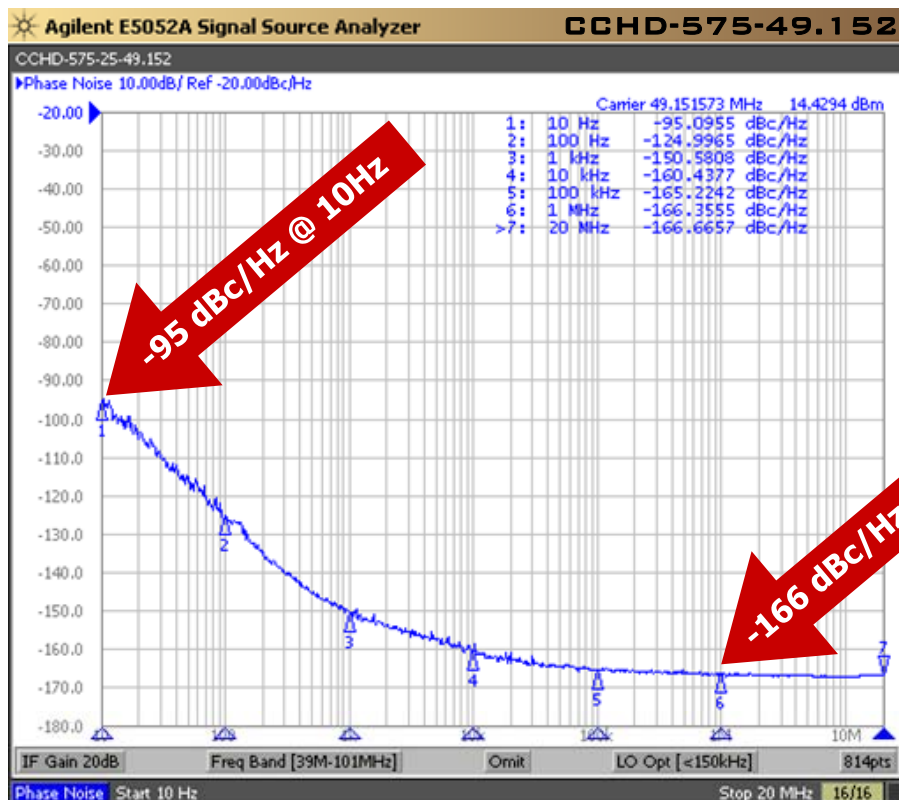
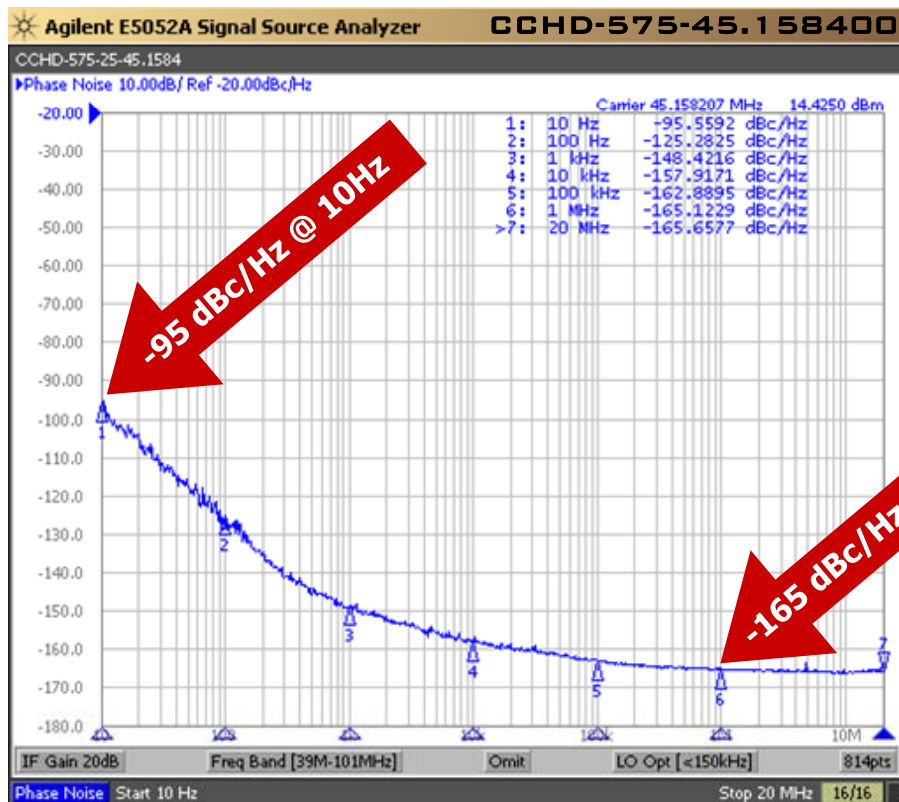

Rev: V
Date: 29-Jun-2020
Page 4 of 5

CCHD-575

Ultra-Low Phase Noise Oscillator

CCHD-575 Model
5×7.5 mm SMD, 3.3V, HCMOS

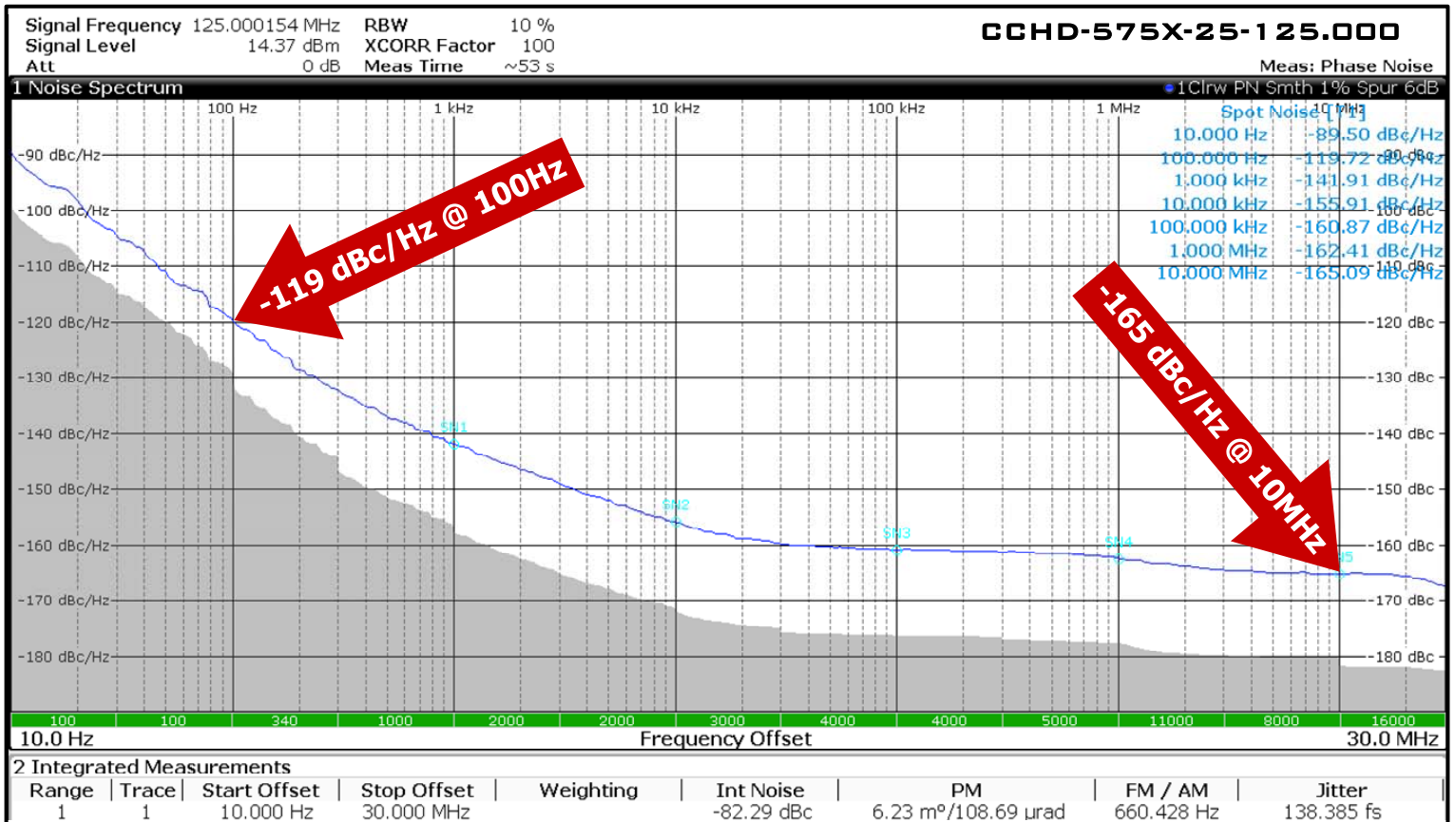

Rev: V
Date: 29-Jun-2020
Page 5 of 5

Mouser Electronics

Authorized Distributor

Click to View Pricing, Inventory, Delivery & Lifecycle Information:

[Crystek:](#)

[CCHD-575-50-100.000](#) [CCHD-575-50-80.000](#) [CCHD-575-25-22.5792](#) [CCHD-575-25-24.576](#) [CCHD-575X-25-100.000](#) [CCHD-575-25-24.000](#) [CCHD-575X-25-125.000](#) [CCHD-575-50-125.000](#)